

# Panasonic®

**Building Passion,  
Building Solutions.**  
Panasonic Air Conditioning Systems

We face a time in which "quality air" differentiates business. It's a time for Panasonic to fully display its strengths. Our ability to assemble and build superior systems isn't just due to the rich resources we have as a comprehensive electronics manufacturer, but also to Panasonic's 100 years of tradition, where each person thinks and acts on their own initiative while working in a team to reach further heights. We do not compromise. Each of our independent selves is a one stop solution. We face our customers' challenges together with our customers and do all that we can to build effective systems. As a true partner for our customers, we strive to always be at the forefront of business.

- Please read the Installation Instructions carefully before installing the unit, and the Operating Instructions before using it.
- Specifications are subject to change without prior notice.
- The contents of this catalogue are accurate as of February 2020.
- Due to printing considerations, the actual colours may vary slightly from those shown.
- All graphics are provided merely for the purpose of illustrating a point.



Do not add or replace refrigerant other than the specified type. Manufacturer is not responsible for the damage and deterioration in safety due to usage of other refrigerant.

Authorised Dealer

FSV Mini FSV ASIA GENERAL\_FEBRUARY 2020



## Panasonic Global Air Conditioner

Global Site : [aircon.panasonic.com](http://aircon.panasonic.com)  
PROclub : [panasonicproclub.global](http://panasonicproclub.global)



[airconpanasonicglobal](https://www.youtube.com/channel/UCaRnpanasonicglobal)

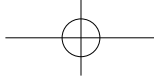

# Panasonic

## FSV VRF SYSTEMS 2020/2021



Residential &  
Light Commercial Use



Commercial Use



# QUALITY AIR FOR LIFE

## A Better Life, A Better World



# THE GAME CHANGER



**ALL INVERTER**

**VRF with Extraordinary Energy-Saving  
Performance and Powerful Operation**

**EER 5.3 (U-8ME2H7)**

A game-changing VRF system delivering energy-saving performance, powerful operation, reliability and comfort surpassing anything previously possible.

It represents a true paradigm shift in air conditioning solutions. Taking quality to the extreme — that's the Panasonic challenge.



Multiple large-capacity all inverter compressors (more than 14HP)

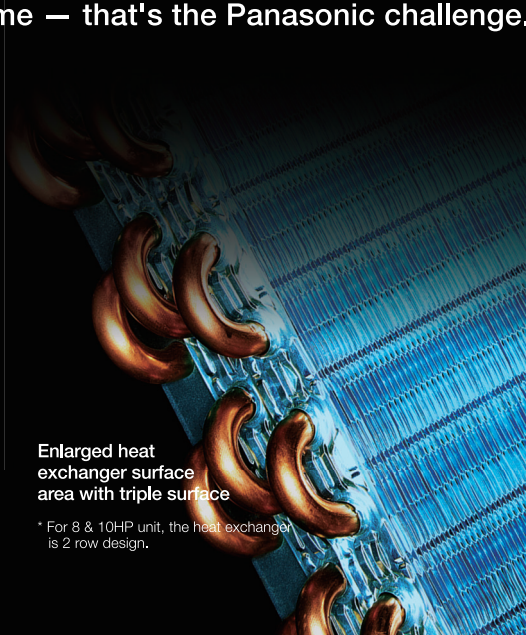

Enlarged heat exchanger surface area with triple surface

\* For 8 & 10HP unit, the heat exchanger is 2 row design.



Newly designed curved air discharge bell mouth for better aerodynamics

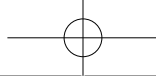

Panasonic  
FSV-EX  
INVERTER

# Extraordinary

# 5.3

EER

In the case of U-8ME 2H7

## CONTENTS

02 FSV-EX Introduction	56 FSV Indoor Units Range	96 FSV Controllers
04 Mini-FSV Introduction	58 F2 Type / Mid Static Ducted	98 Individual Control Systems
06 FSV-EX Advantages	62 M1 Type / Slim Low Static Ducted	101 Timer Operation
08 FSV-EX Series / Exclusive Feature 1 Extended Operation Range	64 Z1 Type / Slim Low Static Ducted Twenty Series	102 Centralised Control Systems
10 FSV-EX Series / Exclusive Feature 2 Energy-Saving Performance	66 E2 Type / High Static Ducted	106 P-AIMS
12 FSV-EX Series / Exclusive Feature 3 Oil Management System	68 E2 Type / Energy Saving High Fresh Air Ducted	108 T10 Terminal for External Control
14 ECONAVI	70 E1 Type / High Static Ducted	109 Interfaces for External Control
16 Exclusive Feature / High-spec Wired Remote Controller	72 H1 Type / High-Fresh Air Ducted	110 Serial Interface for 3rd Party External Controller
20 Exclusive Feature / Air Handling Unit Kit	74 K2 Type / Wall Mounted	111 Serial Interface for LonWorks Network
24 Exclusive Feature / Design Support Software for FSV	78 U2 Type / 4-Way Cassette	112 FSV Controller External Dimensions
26 FSV Systems	82 Y2 Type / 4-Way Mini Cassette	114 VRF Renewal
28 2-WAY FSV-EX ME2 Series	84 L1 Type / 2-Way Cassette	118 A Globally Trusted Air Conditioning Brand
44 2-WAY Mini-FSV LE Series	86 D1 Type / 1-Way Cassette	120 Reliability and Durability
54 Indoor Units	88 T2 Type / Ceiling Mounted	122 Global Networking of Air Conditioning Solutions
	90 P1 Type / Floor Standing	124 Panasonic VRF Global Project References
	92 R1 Type / Concealed Floor Standing	
	94 Remark for High Static Ducted Series	

# MINI GAME CHANGER



## Mini VRF LE Series

Cooling & Heating Type 8/10 HP [LE1] 4/5/6 HP [LE2]

Mini-FSV with Extraordinary Energy-Saving Performance and High External Static Pressure(35Pa)

### High External Static Pressure 35Pa

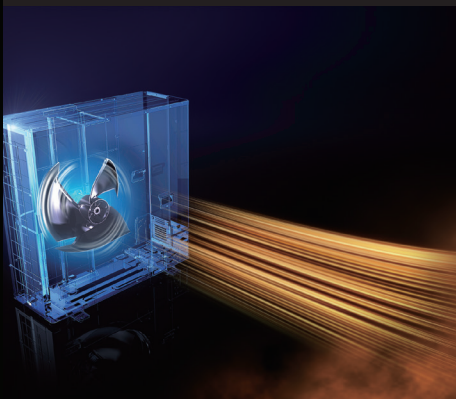

### Compact Design

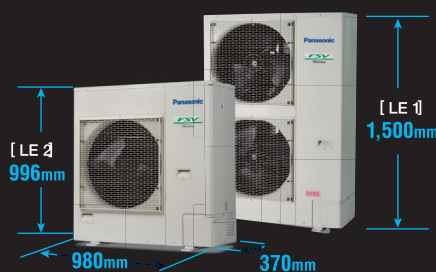

### Long Piping Design Length for Greater Design Flexibility

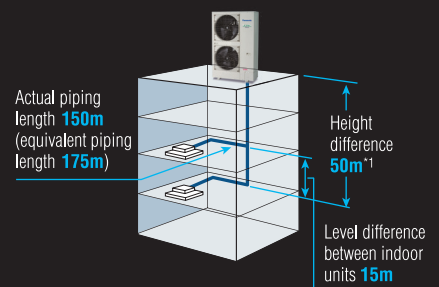

LE1 Max. total piping length: 300m  
LE2 Max. total piping length: 180m

\*1: 40m if the outdoor unit is below the indoor unit.



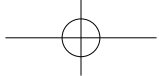

LE1 Series

4.20\*

EER

\* In the case of 8HP



LE2 Series

5.08\*

EER

\* In the case of 4HP

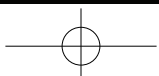

# FSV-EX Advantages

The most efficient, powerful and quiet system in Panasonic's history. There has never been a VRF system like it. It's the story of a true game changer.

## Extraordinary Energy-Saving Performance

The FSV-EX marks a revolutionary step forward in VRF efficiency. A look at the incredible EER value clearly indicates that. What's more, this high EER value is achieved even during part load operation. This shows the extraordinary energy-saving performance the FSV-EX is capable of providing.

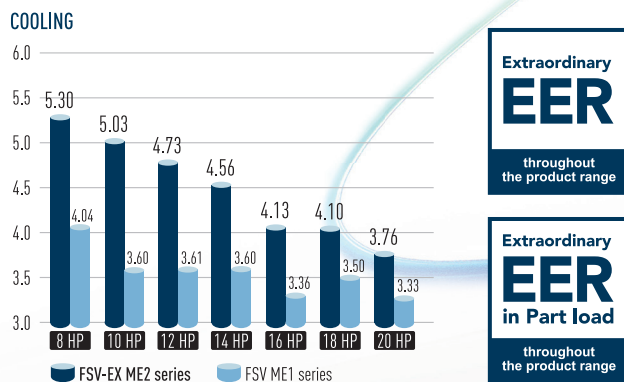

## Extended Operation Range Up to 52°C

The FSV-EX can provide cooling even when the outside temperature reaches a maximum of about 52°C. And amazingly, it can still operate at 100% capacity when the outside temperature is as high as 43°C. This high power capability enables reliable operation even under extremely high temperature conditions.

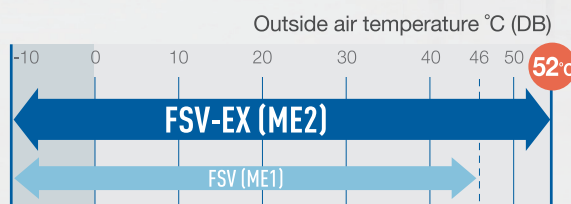





## Low-Noise Operation

Numerous technological innovations, including an improved compressor and a newly designed bell mouth and larger fan, have dramatically reduced the outdoor noise level. The result is an even more comfortable building environment.

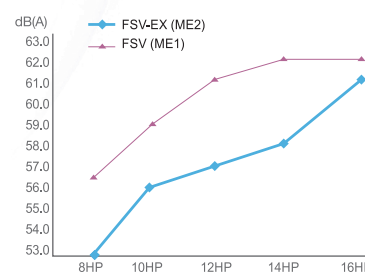

## Multiple large-capacity all inverter compressors

(more than 14HP)

Two independently controlled inverter compressors achieve high efficiency. Redesigned components in the body provide performance improvement especially in the rated cooling condition and EER performance.



## Enlarged heat exchanger surface area with triple surface\*

The new heat exchanger features a triple-surface construction. Compared to the divided dual-surface construction in current models, there is no division of space and the area for heat exchange is larger. Also, highly efficient piping pattern increases heat exchange performance by 5%.

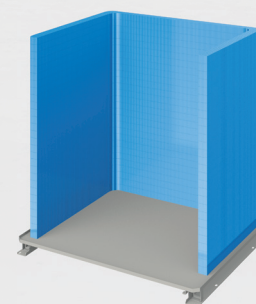

\* For 8 & 10HP unit, the heat exchanger is 2 row design.



# Extended Operation Range up to 52°C

## High reliability even under high temperature conditions

Designed to be durable enough to withstand extreme heat, FSV EX ensures reliable cooling operation over an extended operation range up to 52°C.

### OPERATING RANGE

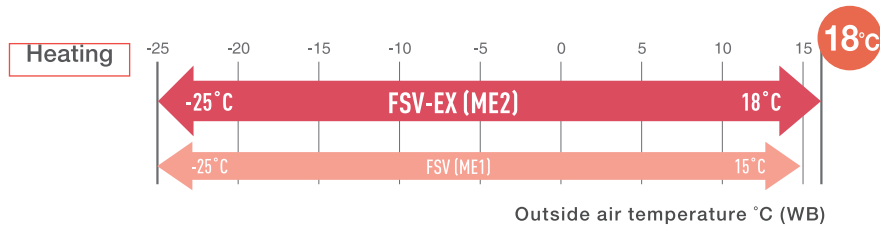
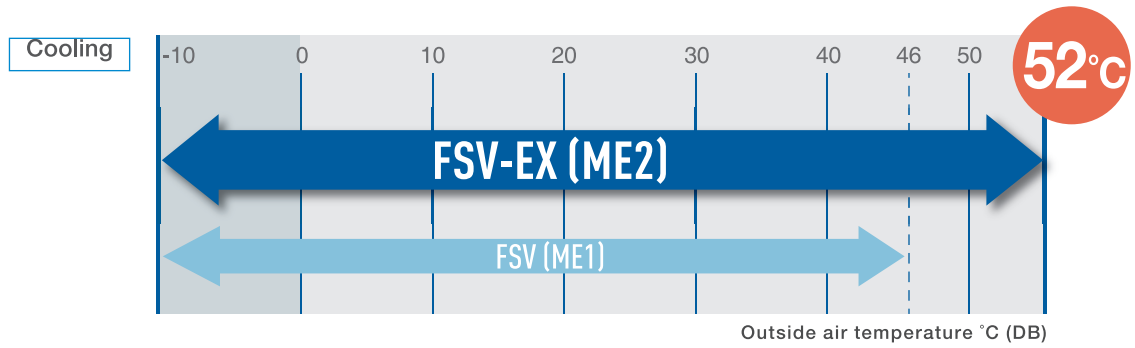

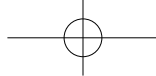

## Full-capacity Operation up to 43°C

The FSV-EX can provide cooling even when the outside temperature reaches a maximum of about 52°C. And amazingly, it can still operate at 100% capacity when the outside temperature is as high as 43°C. This high power capability enables reliable operation even under extremely high temperature conditions.

### CAPACITY RATIO (COOLING)

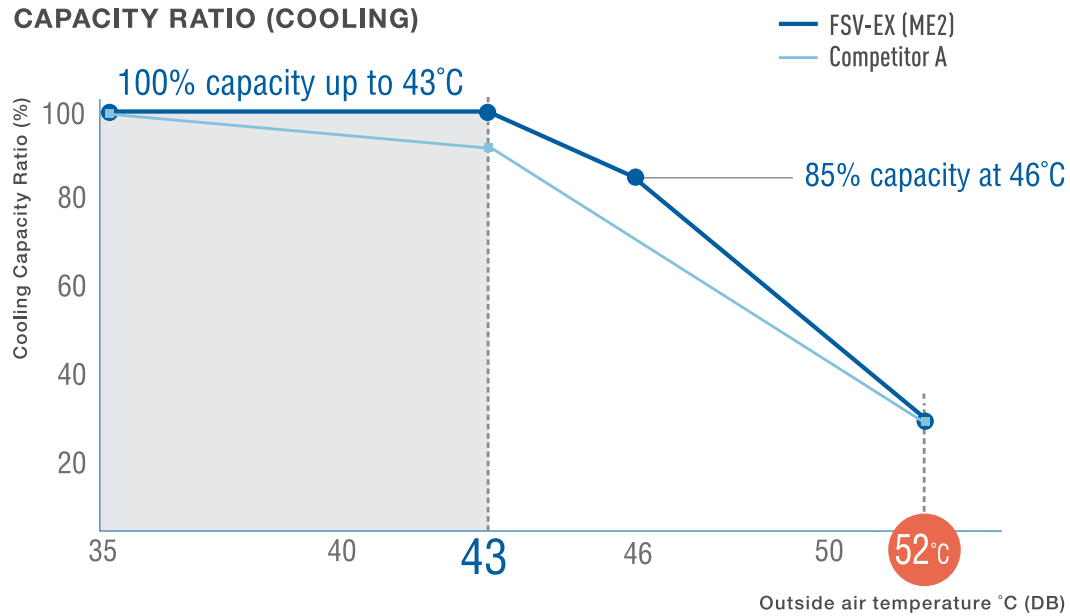

<Test Condition> 12HP model, IU/OU capacity ratio:100%, Indoor Condition:27°C[DB]/19°C[WB]  
Competitor A spec is from technical data book.





# Extraordinary Energy-Saving Performance

## Practical Design for Actual Operation

Panasonic builds air conditioning systems not only with a high EER for rated operation, but also with Seasonal-EER appropriate to the customer's actual environment of use. For instance, with rated operation, outdoor temperature is constant at 35°C, but in reality the outdoor temperature is continuously changing. Consequently, required air conditioning performance also changes. That's why Panasonic implements the following kind of proprietary control.

Rapidly reaches set temperature  
→ full-load operation duration minimised

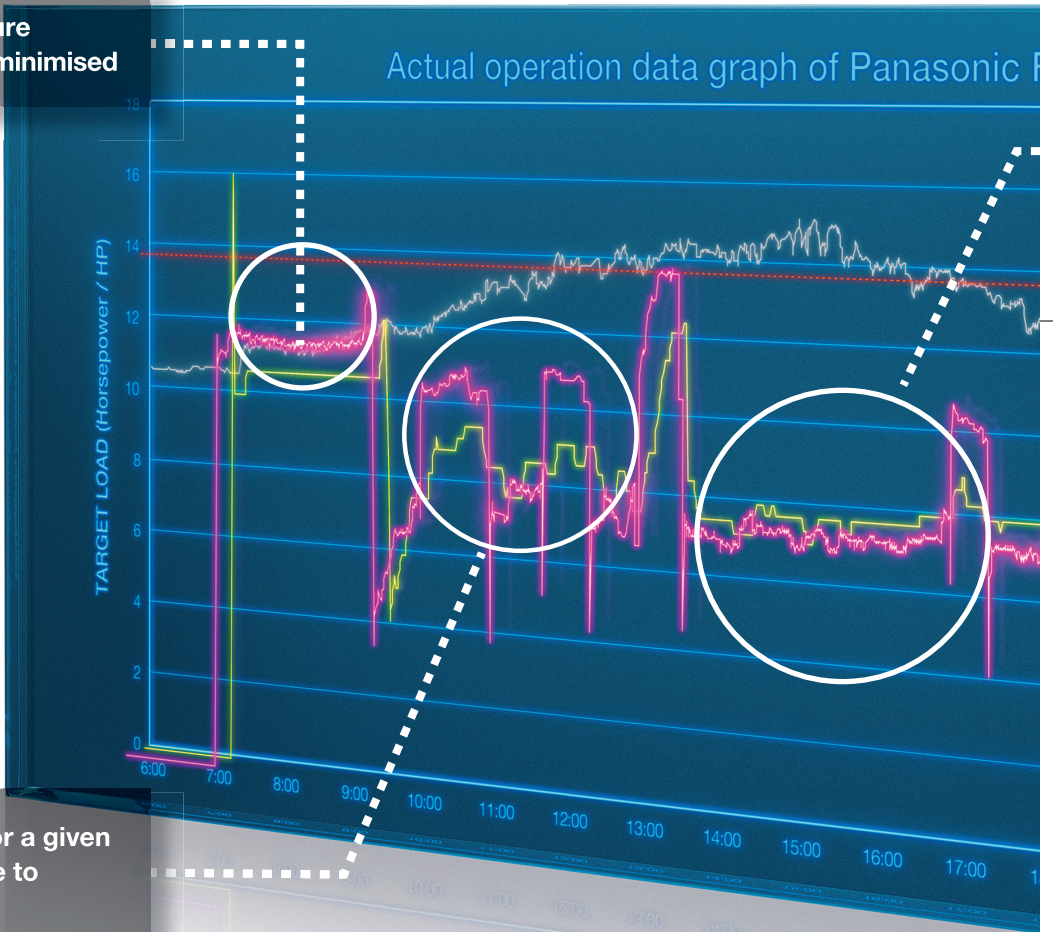

Load increased as required for a given outdoor temperature increase to maintain the set temperature

## Actual performance data of Panasonic FSV installed in Asia

Simulated conditions

Location: Panasonic building in Malaysia System: One 16HP outdoor unit, 4 cassette-type indoor units



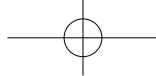

1. Set temperature is rapidly attained; full-load operating time is kept to a minimum.
2. The frequency of forced oil recovery is minimised. The volume of oil within the compressors is monitored precisely by sensors, so forced oil recovery under full-load operation is conducted only when necessary. Since this suppresses noise due to oil recovery, comfort is maintained.
3. Panasonic pursues a high EER, of course, as well as high EER in part load, for energy saving performance under a broad range of loads.

Panasonic's design concept contributes to substantial energy cost reductions.

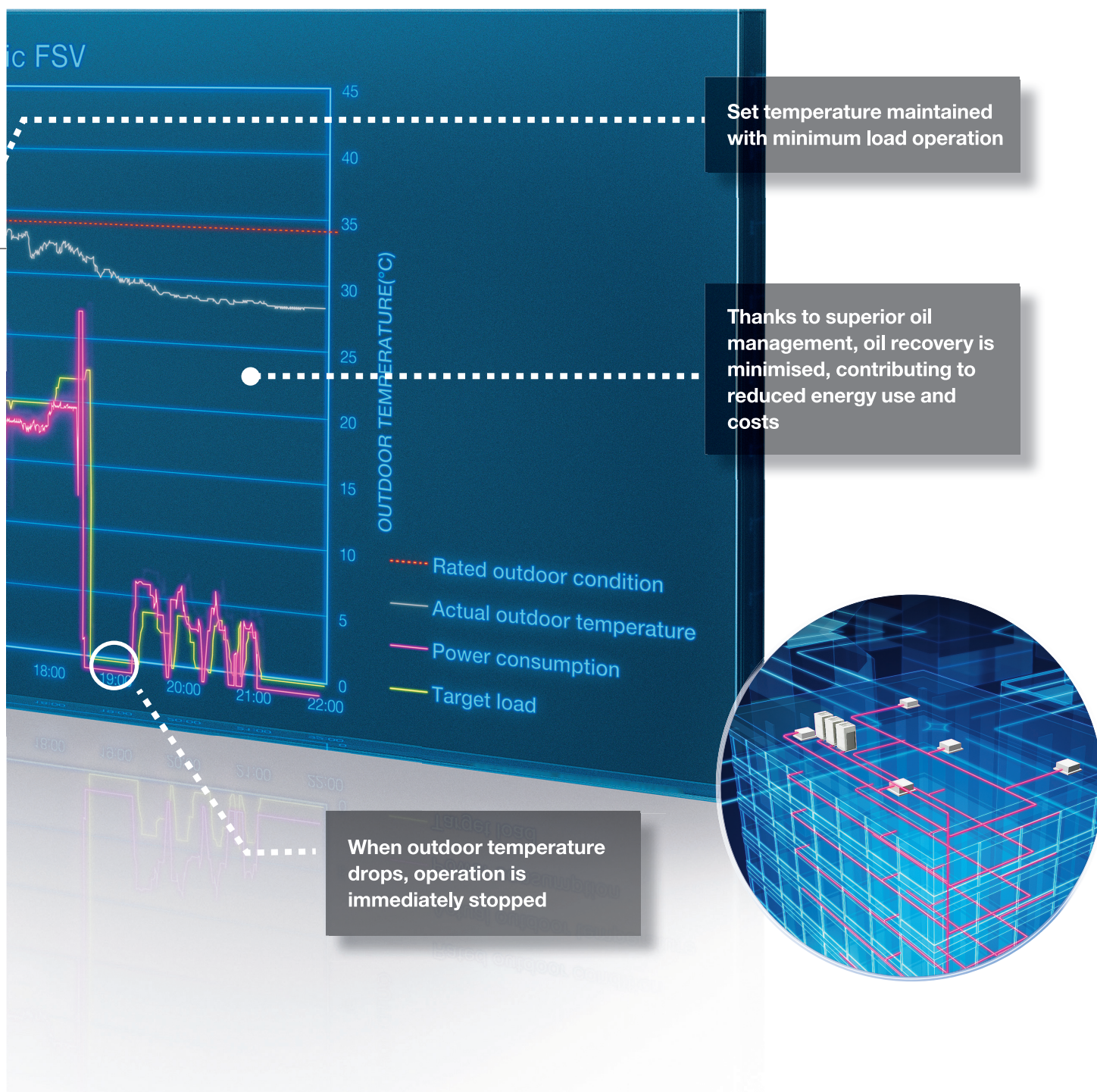



# Intelligent 3-stage Oil Management System

In a VRF system, where lengthy piping and a large number of indoor units need to be controlled collectively, the key to maintaining the system's reliability is to ensure an appropriate amount of oil is secured in the compressors. In order to avoid oil shortage in the compressor, maximum operation is normally forcibly conducted at regular intervals to recover oil from indoor units. This method, typically employed in a standard VRF, causes the system to overheat or overcool and thus waste energy.

In Panasonic VRF systems, a sensor for detecting oil levels is mounted in each compressor. In installations with multiple outdoor units, a shortage of oil in one compressor can be compensated for by recovering oil either from another compressor in the same unit, from a compressor in an adjacent outdoor unit, or from a connected indoor unit. Panasonic VRF systems provide users with a comfortable environment whilst saving energy.

The Panasonic system efficiently manages oil recovery in three stages; minimising the frequency of forced oil recovery while reducing energy cost and maintaining comfort.

## STAGE-1

Panasonic compressors are equipped with sensors which monitor oil levels precisely at all times. If oil levels fall, oil can be transferred from other compressors within the same outdoor unit.

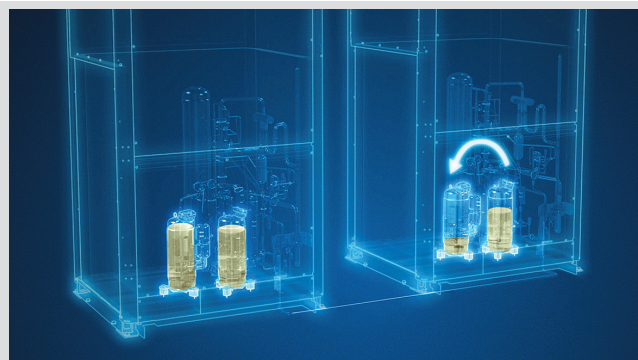

## STAGE-2

If oil levels in all compressors within the outdoor unit fall, oil can be replenished from adjacent outdoor units.

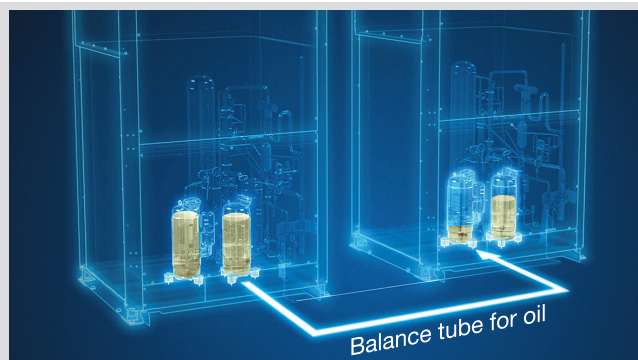

## STAGE-3

Forced oil recovery is implemented only if oil levels become insufficient in spite of above measures. The Panasonic system's design concept is radically different from conventional oil systems.

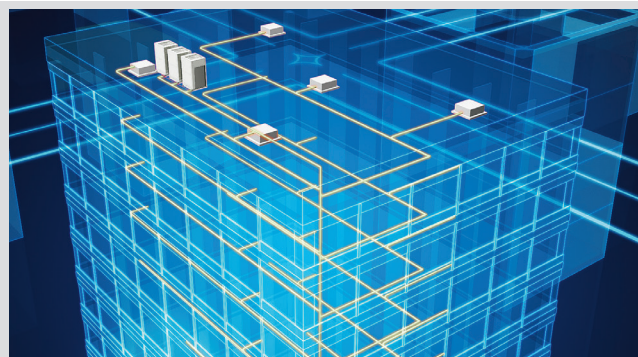



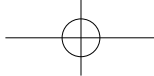

## Features of 3-stage oil recovery design

### 1 Oil sensors installed in each compressor

Oil sensors installed in each Panasonic compressor precisely monitor oil levels, eliminating unnecessary oil recovery.

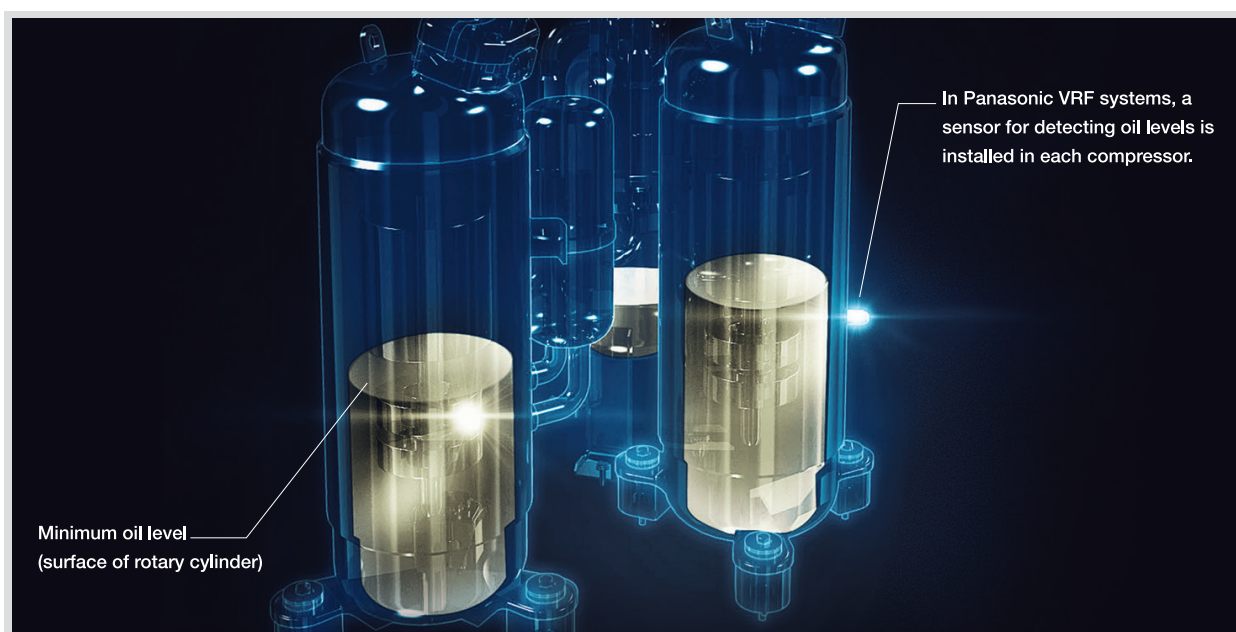

### 2 Highly functional oil separator

Thanks to extended separate piping, oil recovery efficiency reaches 90%, minimising the oil to be discharged from the compressor.

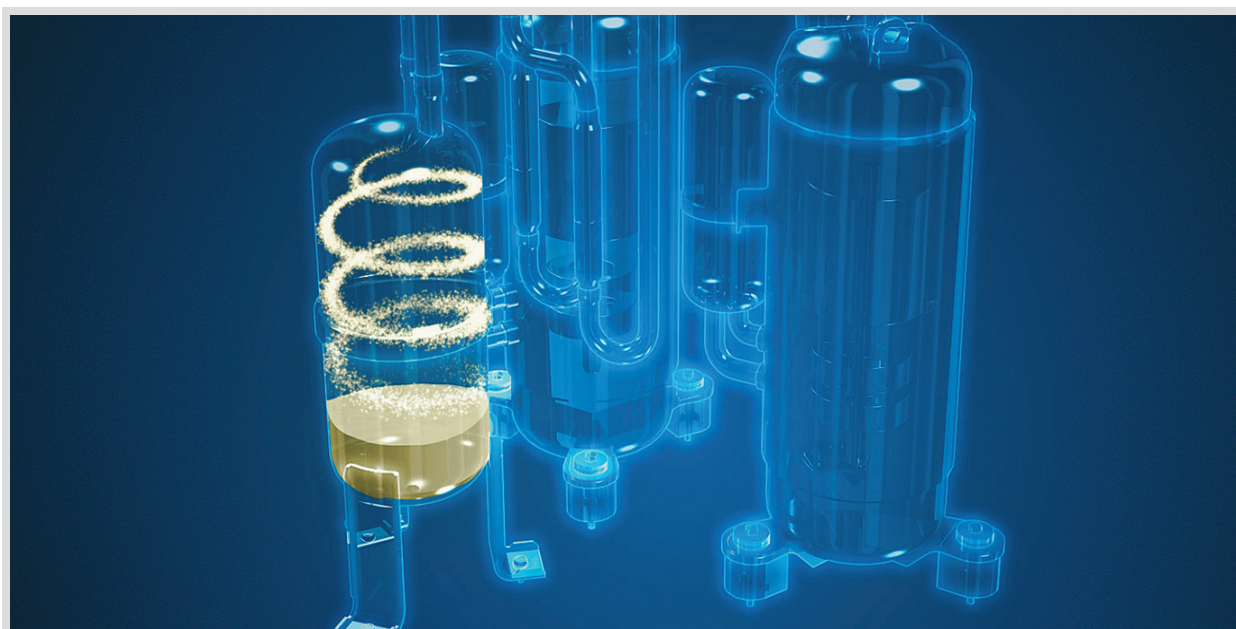



# ECONAVI Detects Inefficiencies and Saves Energy

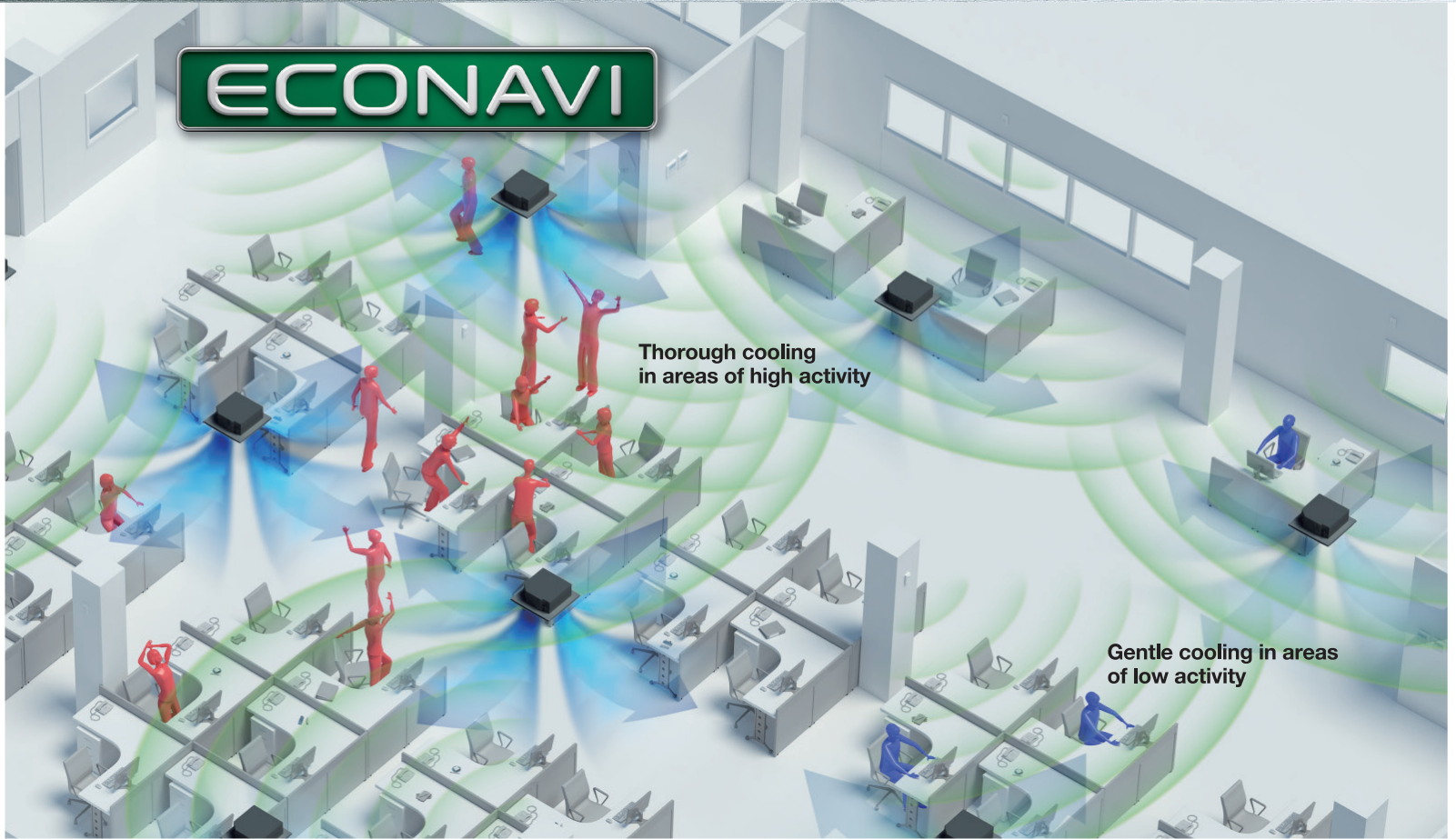

**Detection of the level of activity enables precise power saving.**

Presence or absence of people at their desks and the level of activity in the office are detected in real time. Set temperature is automatically adjusted to optimise the lower power consumption.



**In the morning**  
Thorough cooling when there is a high level of activity



**In the afternoon**  
Reduced cooling when there are fewer people

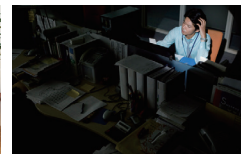



**At night**  
Automatic Thermo Off depending on conditions at the end of the day\*

## Human activity and presence detection

### Activity detection

HIGHER ACTIVITY	LOWER ACTIVITY
Cooling Set Temp. +/-0°C	Cooling Set Temp. +1°C
Heating Set Temp. -1°C	Heating Set Temp. +/-0 °C
Every 2 min	Every 2 min

### Presence detection

After 20 mins absence	After 3 hours absence
Cooling Set Temp. +2°C	Cooling Thermo OFF*
Heating Set Temp. -2°C	Heating Thermo OFF*
After 3 hours the setting can change to Stop or Temperature Shift	



\*Depending on conditions, the setting can change to Switch Off After 3 Hours, Thermo Off or Temperature Shift.



# ECONAVI

## Remote ECONAVI sensor allows optimum energy operation

Pillars, walls, cabinets and other fittings obstruct the sensor, reducing the area of detection and lowering the energy-saving effect. Taking into consideration blind spots, Panasonic enables the optimum layout for sensors in any office.

### Wide detection area

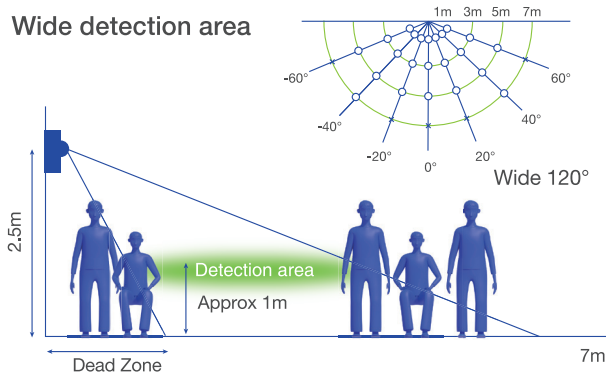

A sensor is remotely set to maximise the detection area.

Installation flexibility ready for indoor unit replacement and layout changes.



ECONAVI sensor  
CZ-CENSC1

## Panasonic enables use with various types of indoor units

Providing outstanding energy-saving performance, Panasonic's inverter VRF System can be connected to ECONAVI to detect when energy is being wasted. ECONAVI senses the presence or absence of people and the level of activity in each area of an office. When unnecessary heating or cooling is detected, indoor units are individually controlled to match office conditions for energy-saving operation.

## ECONAVI VRF Field Test

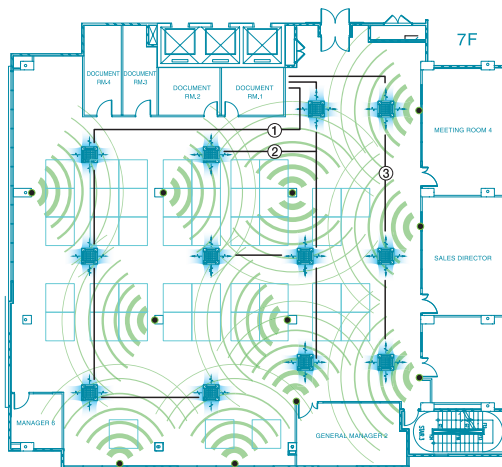

- Indoor units (12)
- Sensors (12)
- Trial term: 11 Apr - 16 May 2014
- Location: Panasonic Malaysia Building
- Office floor: Cooling capacity 112kW
- Testing conditions:
  - Remote controller setting temperature 23°C
  - Setting time AM7:00-PM21:00
- Units used

System	Outdoor unit	Indoor unit
① CU-L7-6	U-20ME1E8	1 S-106MU1E5
		2 S-106MU1E5
		3 S-106MU1E5
		4 S-106MU1E5
		5 S-56MU1E5
② CU-L7-7	U-20ME1E8	6 S-106MU1E5
		7 S-106MU1E5
		8 S-56MU1E5
		9 S-106MU1E5
③ CU-L7-7	U-14ME1E8	10 S-106MU1E5
		11 S-56MU1E5
		12 S-106MU1E5



## Power consumption

Without ECONAVI

With ECONAVI

Up to **15%**  
energy saving

Energy-saving effect  
tested and verified  
by Field test



Exclusive Feature

# High-spec Wired Remote Controller

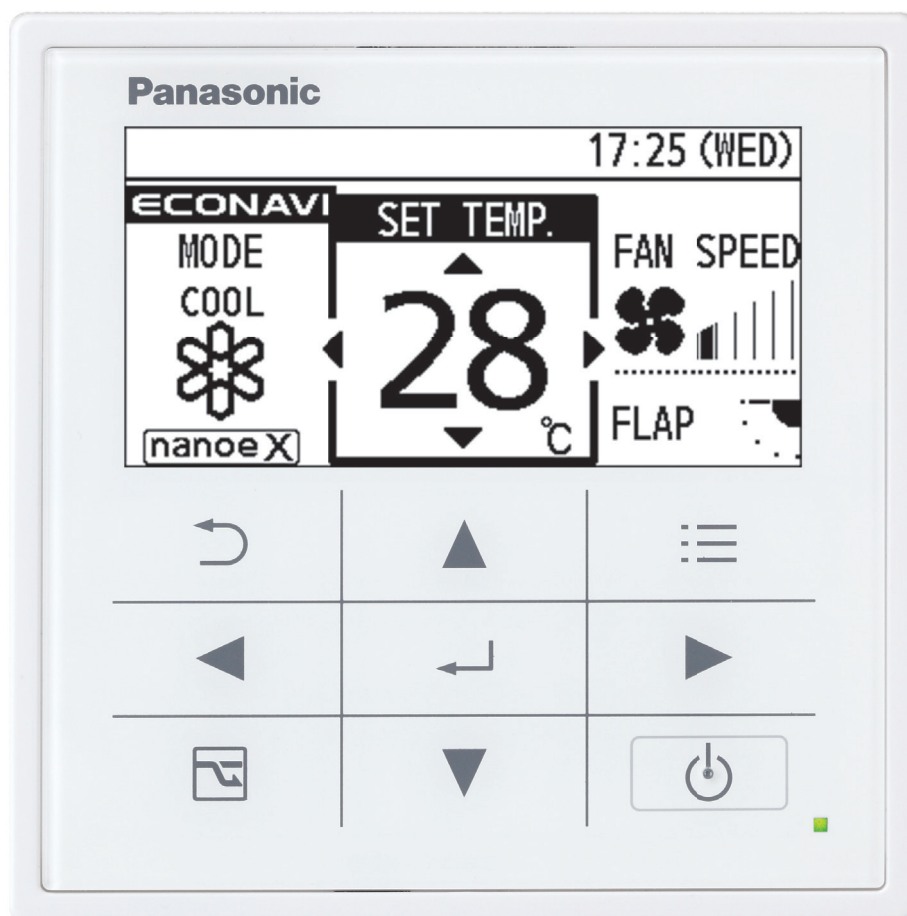

CZ-RTC5B Actual size

## Large 3.5" Full-dot LCD with White LED Backlight

Characters and icons are clearly displayed for improved visibility. The display is also large enough to provide a wide range of information for easy confirmation of operation conditions.

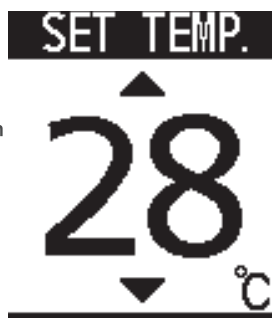

## Stylish, Easy-to-use Touch Key Design

The elegant, flat design features large touch keys in a simple layout enabling easy, intuitive operation.



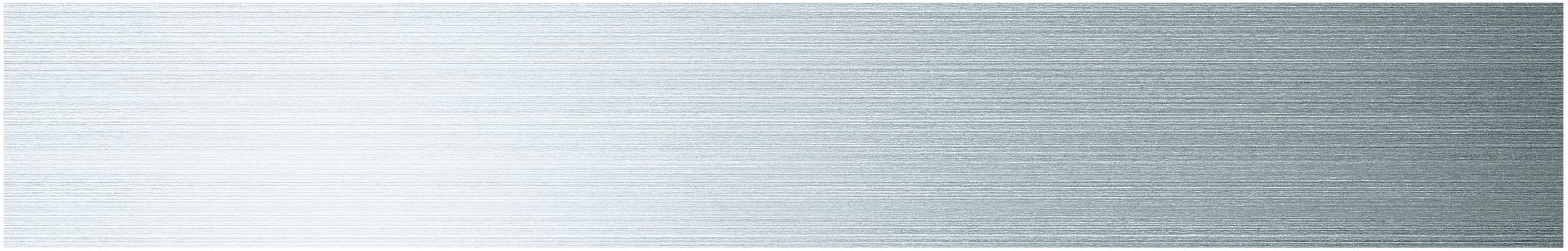
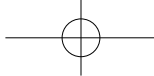

## Multiple control settings to meet a wide range of air conditioning needs

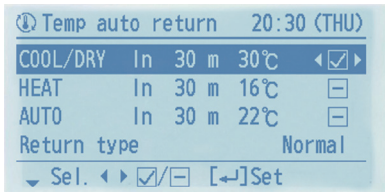

### Temperature Auto Return

Even if you change the temperature setting, after a set time it automatically returns to the original temperature setting. You can set temperature auto return time in 10-minute intervals within a period of 4 hours.

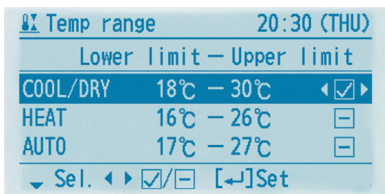

### Temperature Setting Range

You can set the upper and lower temperature limits. Doing this helps reduce power consumption due to over cooling or heating. Setting is possible in the Cooling, Heating and Dry modes.

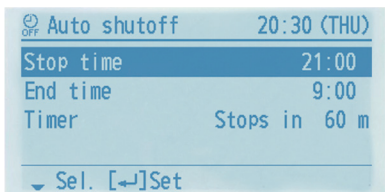

### Auto Shutoff

Air conditioning automatically stops after a set time, so you don't have to worry about forgetting to switch the unit off. Even if you manually switch the unit back on after it has stopped, it automatically switches off again after the set time.

## Wide range of controls for extra convenience

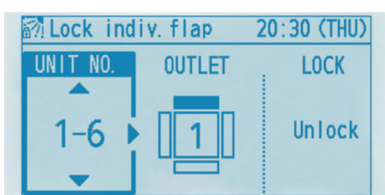

### Individual Flap Control (Lock individual flap only for 4-way cassette U1 type)

Each of the 4-directional outlets can be selected and locked to provide efficient air distribution that matches the indoor unit layout. Indoor units can be set individually.

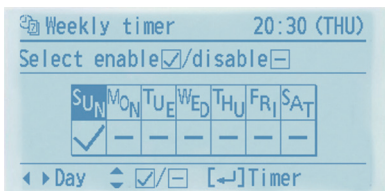

### Weekly Timer

This lets you specify 8 Start/Stop times and temperature presets for each day of the week.

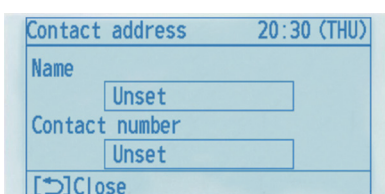

### Service Contact Address

Once you have register service contact details, they are automatically displayed if a problem with the air conditioner occurs. This helps you quickly deal with the situation.



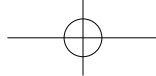

## Convenient Controls

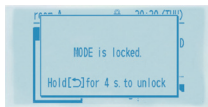

### Operation Lock

To prevent operation by anyone other than the supervisor, operation keys can be locked. This prevents unauthorized personnel from changing temperature settings, airflow rate, airflow direction and other settings.

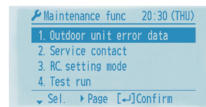

### Maintenance Function

Display of outdoor malfunction data, service contact details, filter cleaning remaining time and other data enables at-a-glance verification of maintenance information with the remote controller.



### Filter Information

Filter information is indicated for cleaning after a set time of operation period has past. The number of hours can be adjusted.

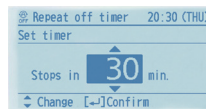

### Repeat OFF Timer

You can stop the operation after a certain period of time each time operation is performed.

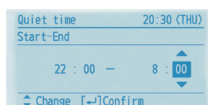

### Quiet Operation Mode

There's a Quiet mode that reduces the outdoor unit's operating noise. The mode can be switched On/ Off and Start/ End times can be set.

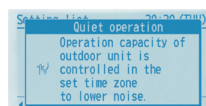

### Setting Lists

Information concerning current settings is displayed in the remote controller's LCD for easy confirmation.

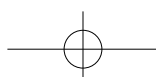
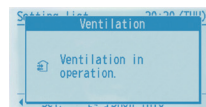
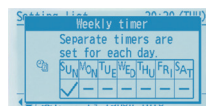

## Function List

Control Item		Controllability	
		"B" model	Non "A-B" model
Menu items	Basic instructions	●	●
	FLAP	●	●
	Individual louver control (Lock individual flap only for 4-way cassette U2 type)	●	●
	ON/ OFF timer	●	●
	Weekly timer	●	●
	Filter information	●	—
	Outing function	●	●
	Quiet operation mode	●	—
	Energy saving	●	●
	Initial settings	●	●
	Ventilation	●	●
Energy Saving	Temperature auto return	●	●
	Temperature setting range	●	●
	Auto shutoff	●	●
	Schedule peak cut	●	—
	Repeat off timer	●	●
	ECONAVI on/ off	●	—
Maintenance Function	Outdoor unit error data	●	—
	Service Contact address	●	●
	RC setting mode	●	●
	Test Run	●	●
	Sensor Information	●	●
	Service check	●	●
	Simple/ Detailed Settings	●	●
	Auto address	●	●



Exclusive Feature

# Air Handling Unit Kit

AHU Kit connects FSV-EX and FSV outdoor units to Air Handling Units System

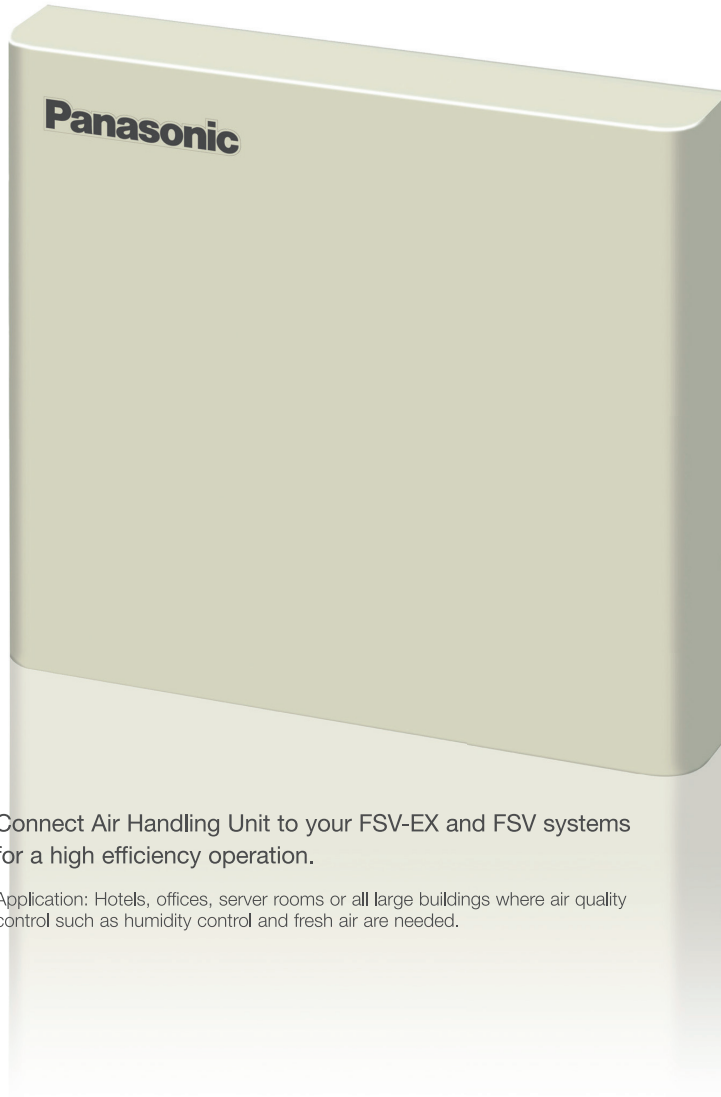

If you require this fresh air solution, please contact an authorized Panasonic distributor.

Connect Air Handling Unit to your FSV-EX and FSV systems for a high efficiency operation.

Application: Hotels, offices, server rooms or all large buildings where air quality control such as humidity control and fresh air are needed.

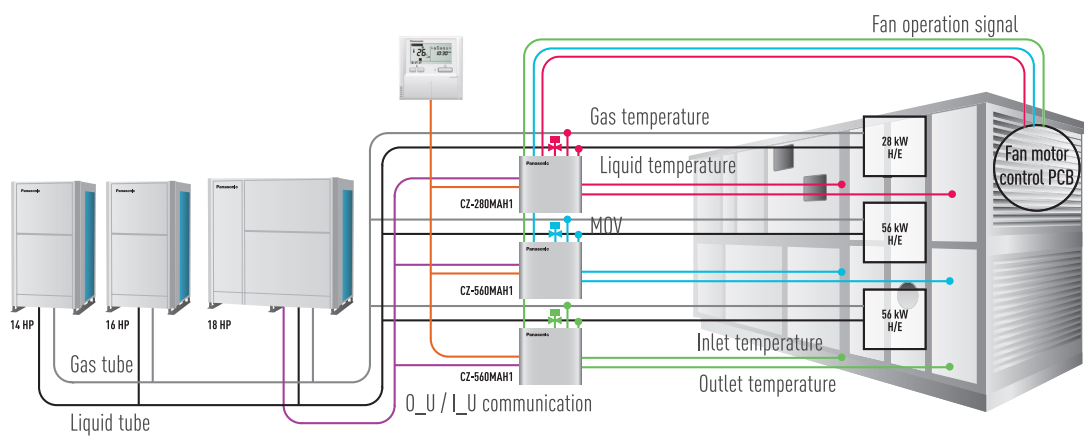



## AIR HANDLING UNIT Kit to connect to your ventilation system

### AHU Connection Kit

PCB, Power trans,  
Terminal block

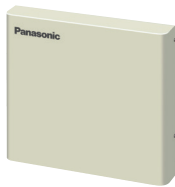

Remote control can be  
easily installed on the  
AHU Kit box.  
(Remote control must be  
purchase separately.)



Expansion  
valve



Thermistor x2  
(Refrigerant: E1, E3)

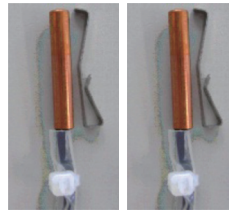

Thermistor x2  
(x1 in PACi) (Air: Tf, Tb)



### Optional Remote controller

Timer remote controller.  
CZ-RTC4



## Optional parts: Following functions are available by using different type of control accessories:

#### CZ-RTC4 Wired remote controller

- Operation-ON/OFF
- Mode select
- Temperature setting
- \* Fan operation signal can be taken from the PCB.

#### T10 terminal

- Input signal= Operation ON/OFF
- Remote controller prohibition
- Output signal= Operating-ON status
- Alarm output (by DC12 V)

#### OPTION terminal, DC12V outlet

- Output signal= Cool / Heat/Fan status
- Defrost
- Thermostat-ON

#### CZ-CAPBC2 Seri-para I/O unit for each indoor unit

- Temperature setting by 0-10 V or 0-140 Ω input signal
- Room (inlet air) temp outlet by 4-20 mA
- Mode select or/and ON/OFF control
- Fan operation control
- Operation status output/ Alarm output

#### Technical Zoom

- Max. piping length: 100m (actual)/ 120m (equivalent)
- Difference between longest and shortest piping from first branch: 10m
- Max. length of branch tubing: 12m
- \* Other conditions to be referred the standard piping design regulations.
- Available temperature range in Heating: -20 °C (WB)~15 °C (WB)
- Available temperature range for the suction air at AHU Kit:  
Cool: 18~32 °C / Heat: 16~30 °C

#### CZ-280MAH1 // CZ-560MAH1

- The system controlled by the suction air (or return air from room) temperature as same as standard indoor unit. (Selectable mode: Automatic / Cooling / Heating / Fan / Dry (but same as Cool))
- The discharge air temperature is also controlled to prevent too-low air discharge in Cooling or too-high air discharge in Heating. (in case of VRF system)
- Demand control (Forcible thermostat-OFF control by operating current)
- Defrost operation signal, Thermo-ON/OFF states output
- External target temperature setting via Indoor/Outdoor signal interface is available with CZ-CAPBC2. (Ex. 0 - 10 V)
- Connectable with P-LINK system



## System and regulations. System overview

- A: AHU Kit controller box (with control PCB)
- B: AHU equipment (Field supplied)
- C: Remote controller (option parts)
- D: Outdoor unit
- E: Gas piping (Field supplied)
- F: Liquid piping (Field supplied)
- G: Electronic expansion valve
- H: Thermistor for Gas pipe (E3)
- I: Thermistor for Liquid pipe (E1)
- J: Thermistor for Suction air (TA)
- K: Thermistor for Discharge air (BL)
- L: Inter unit wiring
- M: Magnetic relay for operating the blower (Field supplied)

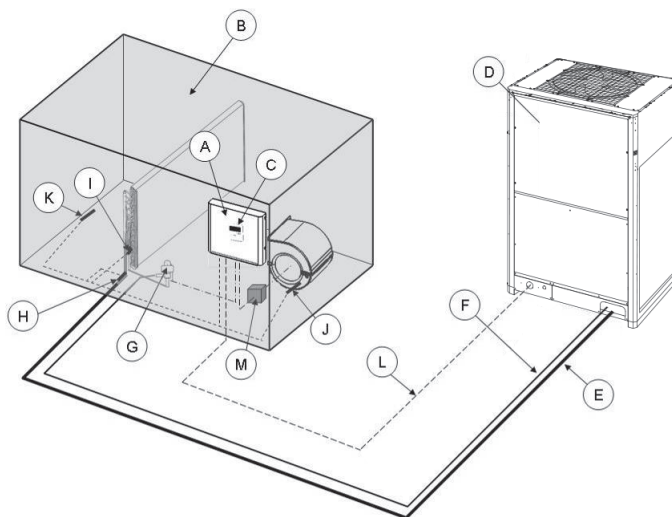

### AHU Connection Kit / System Combination

	Capacity (HP)	Outdoor unit combination			
	22.4 kW (8 HP)	U-8ME2H7			
	28.0 kW (10 HP)	U-10ME2H7			
	33.5 kW (12 HP)	U-12ME2H7			
	40.0 kW (14 HP)	U-14ME2H7			
	45.0 kW (16 HP)	U-16ME2H7			
	50.0 kW (18 HP)	U-18ME2H7			
	56.0 kW (20 HP)	U-20ME2H7			
	61.5 kW (22 HP)	U-10ME2H7	U-12ME2H7		
	68.0 kW (24 HP)	U-12ME2H7	U-12ME2H7		
	73.0 kW (26 HP)	U-10ME2H7	U-16ME2H7		
	78.5 kW (28 HP)	U-12ME2H7	U-16ME2H7		
	85.0 kW (30 HP)	U-14ME2H7	U-16ME2H7		
	90.0 kW (32 HP)	U-16ME2H7	U-16ME2H7		
	96.0 kW (34 HP)	U-14ME2H7	U-20ME2H7		
	101.0 kW (36 HP)	U-16ME2H7	U-20ME2H7		
	107.0 kW (38 HP)	U-18ME2H7	U-20ME2H7		
	113.0 kW (40 HP)	U-20ME2H7	U-20ME2H7		
2-WAY FSV-EX ME2 Series (Space-saving Combination)*	118.0 kW (42 HP)	U-10ME2H7	U-16ME2H7	U-16ME2H7	
	124.0 kW (44 HP)	U-12ME2H7	U-16ME2H7	U-16ME2H7	
	130.0 kW (46 HP)	U-14ME2H7	U-16ME2H7	U-16ME2H7	
	135.0 kW (48 HP)	U-16ME2H7	U-16ME2H7	U-16ME2H7	
	140.0 kW (50 HP)	U-14ME2H7	U-16ME2H7	U-20ME2H7	
	145.0 kW (52 HP)	U-16ME2H7	U-16ME2H7	U-20ME2H7	
	151.0 kW (54 HP)	U-14ME2H7	U-20ME2H7	U-20ME2H7	
	156.0 kW (56 HP)	U-16ME2H7	U-20ME2H7	U-20ME2H7	
	162.0 kW (58 HP)	U-18ME2H7	U-20ME2H7	U-20ME2H7	
	168.0 kW (60 HP)	U-20ME2H7	U-20ME2H7	U-20ME2H7	
	174.0 kW (62 HP)	U-14ME2H7	U-16ME2H7	U-16ME2H7	U-16ME2H7
	180.0 kW (64 HP)	U-16ME2H7	U-16ME2H7	U-16ME2H7	U-16ME2H7
	185.0 kW (66 HP)	U-10ME2H7	U-16ME2H7	U-20ME2H7	U-20ME2H7
	190.0 kW (68 HP)	U-12ME2H7	U-16ME2H7	U-20ME2H7	U-20ME2H7
	196.0 kW (70 HP)	U-10ME2H7	U-20ME2H7	U-20ME2H7	U-20ME2H7
	202.0 kW (72 HP)	U-16ME2H7	U-16ME2H7	U-20ME2H7	U-20ME2H7
208.0 kW (74 HP)	U-16ME2H7	U-18ME2H7	U-20ME2H7	U-20ME2H7	
213.0 kW (76 HP)	U-16ME2H7	U-20ME2H7	U-20ME2H7	U-20ME2H7	
219.0 kW (78 HP)	U-18ME2H7	U-20ME2H7	U-20ME2H7	U-20ME2H7	
224.0 kW (80 HP)	U-20ME2H7	U-20ME2H7	U-20ME2H7	U-20ME2H7	

\*These are combination examples for space-saving combination. These combinations are also compatible for high efficiency models on page 34-35.

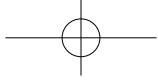

## Project References

### Office

Hong Kong **ed** Cross Headquarters



Air Conditioning System:  
VRF 2-way FSV ME1 series:  
2 systems  
Indoor Units: 2 units  
AHU Kit: 6 units  
Cooling Capacity: 280 kW / 80 USRT



### Residential + Commercial

Malaysia **Utropolis**, Glenmarie



Air Conditioning System:  
VRF 2-way FSV ME1 series:  
29 systems  
Indoor Units: 168 units  
AHU Kit: 9 units  
Cooling Capacity: 3,077 kW / 875 USRT



#### AHU Connection Kit / System Combination

##### AHU kit combination

CZ-280MAH1			
CZ-280MAH1			
CZ-560MAH1			
CZ-560MAH1			
CZ-560MAH1			
CZ-560MAH1			
CZ-560MAH1			
CZ-560MAH1	CZ-280MAH1		
CZ-560MAH1	CZ-280MAH1		
CZ-560MAH1	CZ-280MAH1		
CZ-560MAH1	CZ-280MAH1		
CZ-560MAH1	CZ-280MAH1		
CZ-560MAH1	CZ-560MAH1		
CZ-560MAH1	CZ-560MAH1		
CZ-560MAH1	CZ-560MAH1		
CZ-560MAH1	CZ-560MAH1		
CZ-560MAH1	CZ-560MAH1		
CZ-560MAH1	CZ-560MAH1	CZ-280MAH1	
CZ-560MAH1	CZ-560MAH1	CZ-280MAH1	
CZ-560MAH1	CZ-560MAH1	CZ-280MAH1	
CZ-560MAH1	CZ-560MAH1	CZ-280MAH1	
CZ-560MAH1	CZ-560MAH1	CZ-280MAH1	
CZ-560MAH1	CZ-560MAH1	CZ-560MAH1	
CZ-560MAH1	CZ-560MAH1	CZ-560MAH1	
CZ-560MAH1	CZ-560MAH1	CZ-560MAH1	
CZ-560MAH1	CZ-560MAH1	CZ-560MAH1	
CZ-560MAH1	CZ-560MAH1	CZ-560MAH1	CZ-280MAH1
CZ-560MAH1	CZ-560MAH1	CZ-560MAH1	CZ-280MAH1
CZ-560MAH1	CZ-560MAH1	CZ-560MAH1	CZ-280MAH1
CZ-560MAH1	CZ-560MAH1	CZ-560MAH1	CZ-280MAH1
CZ-560MAH1	CZ-560MAH1	CZ-560MAH1	CZ-560MAH1
CZ-560MAH1	CZ-560MAH1	CZ-560MAH1	CZ-560MAH1
CZ-560MAH1	CZ-560MAH1	CZ-560MAH1	CZ-560MAH1
CZ-560MAH1	CZ-560MAH1	CZ-560MAH1	CZ-560MAH1
CZ-560MAH1	CZ-560MAH1	CZ-560MAH1	CZ-560MAH1
CZ-560MAH1	CZ-560MAH1	CZ-560MAH1	CZ-560MAH1



Exclusive Feature

# Design Support Software for FSV



Features the unique Mounting Scheme function providing more thorough spec-in and tender quotation support for easier, faster completion of work.

The screenshot displays the Panasonic VRF Designer software interface. The main window shows a floor plan with a VRF system layout. The system includes an outdoor unit (U-21188) and four indoor units (S-22011ES1) connected to various rooms: bedroom/flex room, bedroom, bathroom, living/dining/kitchen, and mudroom. A warning message states "Equivalent Length is too long, please amend." The software interface includes a menu bar, a toolbar, a Project Explorer, and a Navigator. A "Create System Wizard" dialog box is open, showing the "Add Indoor Unit" step. The dialog box contains the following information:

Unit Information	
Unit Name	Room Name
FCU 1	Hany's Conference Room
Indoor Unit	
<input type="checkbox"/> Manual selection	
Indoor Unit Type: 4-way Cassette 90x90 (MU1)	
Unit Temperature	
<input type="checkbox"/> Use temperature from room	
Cooling DB	27 °C
Heating DB	20 °C
RH	46.3 %
Requirements of capacity	
Total Capacity	11 kW
Sensible Capacity	8 kW
Heating Capacity	10 kW

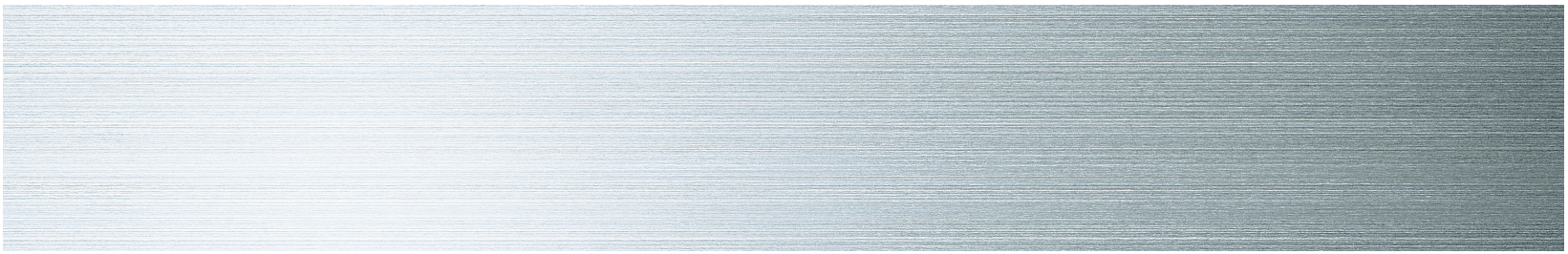
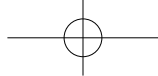

## The Panasonic VRF Designer software can be used for all Panasonic FSV and FSV-EX ranges

Panasonic has identified the importance of ever-increasing demands for fast and accurate responses to customer requests in our industry. More and more emphasis is being placed upon energy-efficiency in our marketplace. The ability to calculate cooling/heating loads and produce information of actual design conditions is a major advantage to any architect, consultant, contractor or end user.

Panasonic understands the time-poor and demanding industry we are in and we are pleased to announce the launch of the next generation of our system design software program.

The Panasonic VRF Designer software has been customised to make the selection and design process as quick and easy as possible.

The design package utilises system wizards and import tools to enable both simple and complex systems to be created. In addition, the system will allow outdoor and indoor units to be dragged on an interactive desktop. This allows users to create everything from realistic floor plans with detailed piping and wiring schematics to send out with quotations, through to installation guidance drawings.

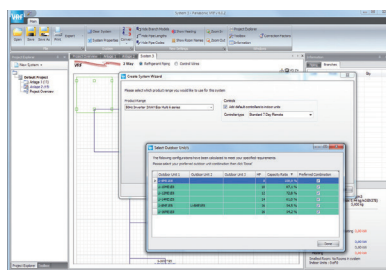
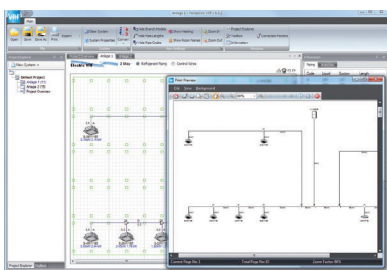
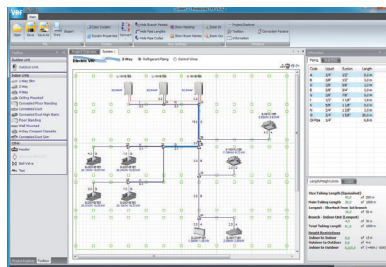
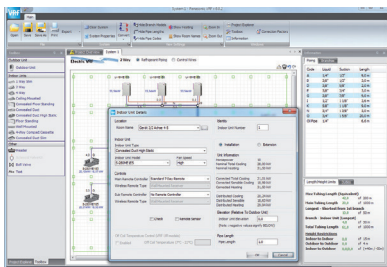

### Features include

- Mounting scheme  
Design selection from building floor drawing.
- Any kind of drawing format.  
(dxf, jpg, png..etc.)
- Conventional principal scheme.
- Easy to use system wizards.
- Auto piping and wiring features.
- Converted duties for conditions and pipework
- Auto(CAD) [dxf], Excel and PDF export.
- Detailed wiring and pipework diagrams.
- Automatic price quotation.
- Automatic tender document assist.





# FSV Systems

FSV systems are designed for energy savings, high efficiency, and high durability with strong cooling power even operating at high ambient temperature. Panasonic continuously apply advanced technologies to meet the requirements of diverse situations and contribute to the creation of comfortable living spaces.



## 2-WAY FSV-EX ME2 Series

Extraordinary energy-saving performance and powerful operation

### Space-saving Combination Model

Cooling or Heating Type

Hi-Durability Model

- Wide range of systems from 8HP to 80HP
- Class-leading EER of 5.3 (for 8HP model)
- Industry-leading low noise of 53.0 DB (8HP model)
- Cooling operation possible with outdoor temperature as high as 52°C (DB)
- Long maximum pipe length (up to 1,000 m)
- Up to 64 indoor units connectable
- External static pressure of 80 Pa
- Extended operating range allows heating with outdoor temperatures as low as -25°C (WB)
- Suitable for R22 refurbishing projects 



### High Efficiency Combination Model

Cooling or Heating Type

Hi-Durability Model

- Wide range of systems from 8HP to 64HP
- Class-leading EER of 5.3 (for 8HP model)
- Higher EER than the Space-saving Combination Model  
e.g., a combination of two 10HP units delivering 20HP reduces compressor load.





## 2-WAY Mini-FSV LE2 Series

For small-scale commercial and residential use

Cooling or Heating Type 1/3-phase **4/5/6 HP**

- High external static pressure 35Pa
- Wide operation range: Cooling: -10°C to 46°C DB, Heating at: -20°C to 18°C WB
- Refrigerant chargeless up to 50m
- Extraordinary energy saving: 5.08\* EER for 4HP model
- Demand response (Peak cut) by optional parts.
- Maximum number of connectable indoor units : 9\*
- Diversity ratio 50-130%
- DC inverter technology combined with R410A for excellent efficiency
- Demand response (Peak cut) by optional parts.
- One ampere starting current
- Full range of indoor units and control options
- Auto restart from outdoor unit
- Hi-durability outdoor unit model is available.
- Suitable for R22 renewal projects 

\* 6 HP only; 4 HP for 7 units, 5 HP for 8 units.



## 2-WAY Mini-FSV LE1 Series

For small-scale commercial and residential use

Cooling or Heating Type 3-phase **8/10 HP**

- High external static pressure 35Pa
- Wide operation range: Cooling: -10°C to 46°C DB, Heating at: -20°C to 18°C DB
- Maximum number of connectable indoor units : 13
- Diversity ratio 50-130%
- DC inverter technology combined with R410A for excellent efficiency
- Actual piping length: 150m (Total piping length: 300m)
- System difference of elevation:50m /40m (outdoor above/below)
- Difference in elevation between indoor units:15m
- Demand response (Peak cut) by optional parts.
- One ampere starting current
- Full range of indoor units and control options
- Auto restart from outdoor unit
- Hi-durability outdoor unit model is available.
- Suitable for R22 renewal project 





High-efficiency & Space-saving VRF system

# 2-WAY FSV-EX ME2

## Remarkable improvement on key components





## Extraordinary energy-saving performance

### 1 Multiple large-capacity all inverter compressors (more than 14HP)

Two independently controlled inverter compressors achieve high efficiency. Redesigned components in the body provide performance improvement especially in the rated cooling condition and EER performance.



### 2 Enlarged heat exchanger surface area with triple surface\*

The new heat exchanger features a triple-surface construction. Compared to the divided dual-surface construction in current models, there is no division of space and the area for heat exchange is larger.

Also, highly efficient piping pattern increases heat exchange performance by 5%.

\* For 8 & 10HP unit, the heat exchanger is 2 row design.



Conventional model [ME1]

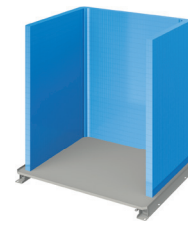

New model [ME2]

## Redesigned for smooth and better air discharge

### 3 Newly designed curved air discharge bell mouth for better aerodynamics

The new curved shape with integrated top and bottom assure smooth exhaust flow. This gives more air-volume with same sound level, less power input at same air-volume.

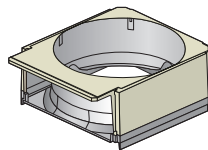

Conventional model [ME1]

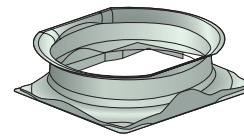

New model [ME2]

### 4 Large air discharge area with new flush surface top panel

To reduce air resistance, instead of a tubular fan design, a new large flat fan guard design, flush with the top panel, is employed. This design lead to the improvements in air resistance, but also contributed to better appearance designing.



Conventional model [ME1]



New model [ME2]



High-efficiency & Space-saving VRF system

# 2-WAY FSV-EX ME2



## A large number of indoor units can be connected

Up to 64 indoor units can be connected in a single system for ultimate design flexibility.

\*Maximum number of indoor units depends on outdoor unit capacity.

**Up to 64** Indoor Units Connectable\*



## Increased piping length for greater design flexibility

Adaptable to various building types and sizes  
Actual piping length : 200m  
Max piping length : 1,000m

\*Elevation difference of Max. 90m in case of ODU is higher than IDU may be allowed following certain conditions. Please consult with Panasonic sales engineers in case of piping elevation of over 50m is required.

\*1: 40 m if the outdoor unit is below the indoor unit.

Max. total length: 1,000m

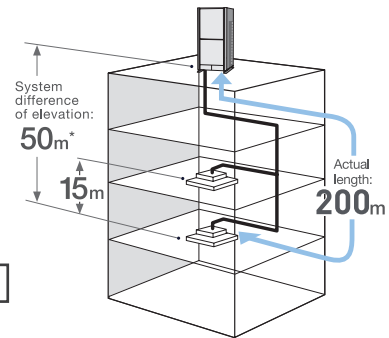

## Connectable indoor/outdoor unit capacity ratio up to 130% \*

FSV systems attain maximum indoor unit connection capacity of up to 130 %\* of the unit's connection range, depending on the outdoor and indoor models selected. So for a reasonable investment, FSV systems provide an ideal air conditioning solution for locations where full cooling/heating are not always required.

SYSTEM / HP	8	10	12	14	16	18	20	22	24	26	28	30	32	34	36	38	40	42	44	46	48	50	52	54	56	58	60	62	64	66	68	70	72	74	76	78	80	
MNcIU : 130%	13	16	19	23	26	29	33	36	40	43	46	50	53	56	59	63	64	64	64	64	64	64	64	64	64	64	64	64	64	64	64	64	64	64	64	64	64	64

MNcIU : Maximum Number of Connectable Indoor Unit

Note: If more than 100% indoor units are operated with a high load, the units may not perform at the rated capacity. For the details, please consult with an authorised Panasonic dealer

\* If the following conditions are satisfied, the effective range is above 130 % up to 200 %.  
i ) Obey the limited number of connectable indoor units.  
ii ) The lower limit of operating range for heating outdoor temperature is limited to -10°CWB (standard -25°CWB).  
iii ) Simultaneous operation is limited to less than 130 % of connectable indoor units.

## Excellent energy savings

The operation efficiency has been improved using highly efficient R410A refrigerant, new DC inverter compressor, and new heat exchanger design.

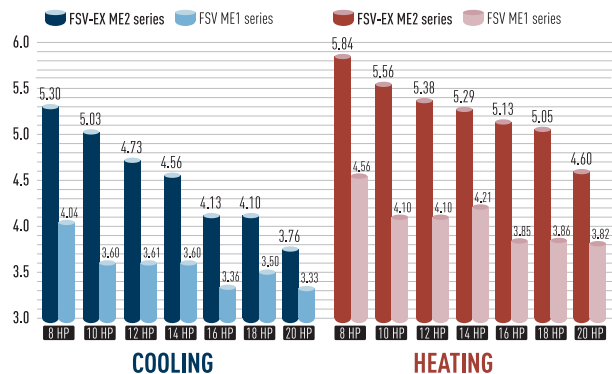



### Up to 50m length difference between the longest and the shortest piping from the first branch

Flexible piping layout makes it easier to design systems for locations such as train stations, airports, schools and hospitals.

- Up to 64 units can be connected to one system.
- Difference between maximum and minimum pipe runs after first branch can be a maximum of 50m.
- Larger pipe runs can be up to 200m.

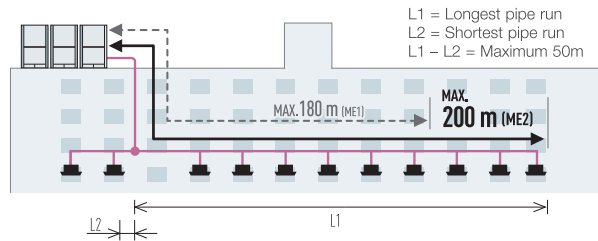

### Extended operating range

#### Cooling operation range:

-10°C DB to +52°C DB

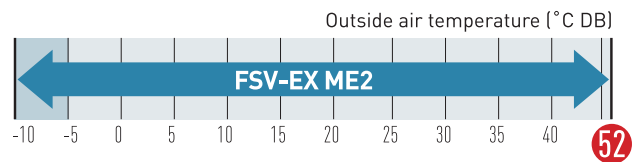

#### Heating operation range:

Extended heating operation range enables heating even when the outdoor temperature is as low as -25°C. Using a wired remote control, indoor heating temperature range can be set from 16°C to 30°C\*.

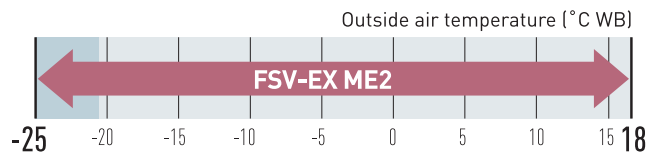

\* Depending on the type of remote controller.

### Compact design

The new ME2 series has reduced the installation space required with up to 20 HP available in a single chassis. 8 - 10 HP are able to fit inside a lift for easy handling on site.

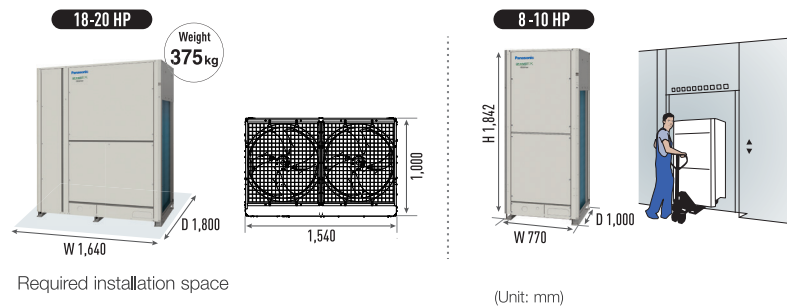

### Newly designed fan

#### Optimised air flow

Newly designed fan and bell-mouth reduces stress on the fan by dispersing air quickly. Thus, lower air resistance results in lower energy consumption.

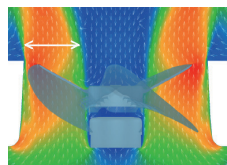

#### Noise reduction

Turbulence (blue) can be suppressed and the unwanted noise can be reduced. Even though a high speed fan is utilised, the noise level is still very low.

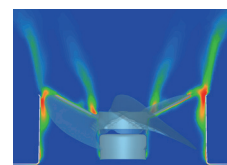



High-efficiency & Space-saving VRF system

# 2-WAY FSV-EX ME2



## High external static pressure on condensers

With a newly designed fan, fan guard, motor, and casing, new models can be custom-installed on-site to provide up to 80 Pa of external static pressure. An air discharge duct prevents shortages of air circulation, allowing outdoor units to be installed on every floor of a building.



Fan



Fan Motor and Casing

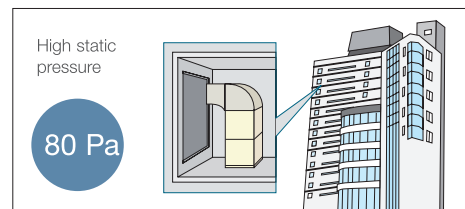

## Extended compressor life by uniform compressor operation time

The total run-time of compressors are monitored by a built-in microcomputer, which ensures that operation times of all compressors within the same refrigerant circuit are balanced.

Compressors with histories showing shorter run times are selected first, ensuring equal wear and tear across all units and extended the working life of the system.

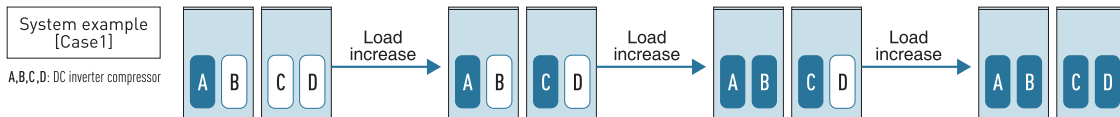

A,B,C,D: DC inverter compressor

\* Depend on accumulated operation time of each compressors.  
 \* Compressor priority has possibility to be changed.  
 (e.g) Case1: A→C→B→D, Case2: C→A→D→B, Case3: A→C→D→B, Case4: C→A→B→D

## Automatic backup operation in the case of compressor failure or outdoor unit malfunction

### Except for 8, 10 & 12 HP single unit installation

\*Backup operation allows uninterrupted cooling or heating to continue whilst waiting for service.  
 Users should contact their authorised service centre as soon as fault occurs.

Even if a whole outdoor unit fails



The other outdoor unit can keep running

Even if a compressor in a single system fails



The other compressor can keep running

**Automatic backup operation.**

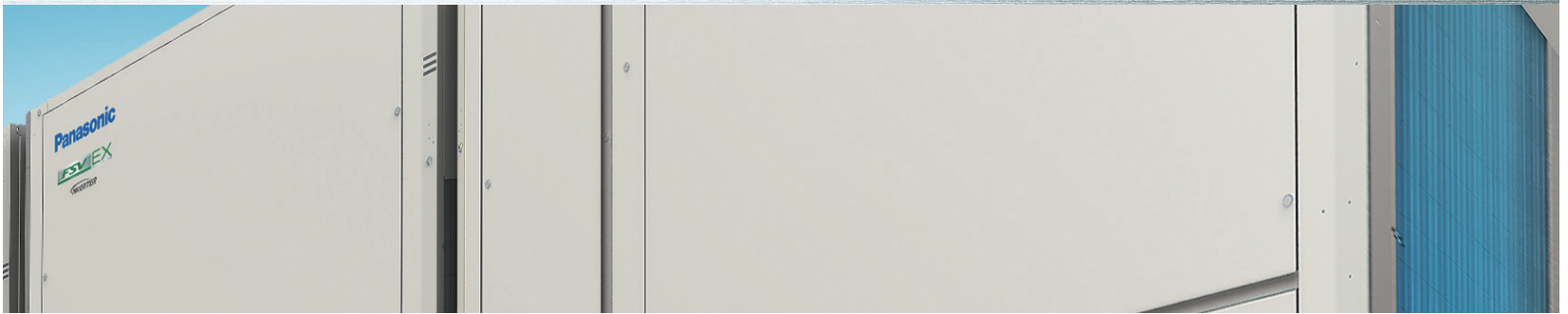

## Demand response

Featuring inverter control technology, all Panasonic FSV systems are Demand Response Management (DRM) ready. With this control, power consumption at times of peak load can be set in three steps to deliver optimum performance. This helps to reduce annual power consumption with minimal loss in comfort.

### Simple Demand Response with the CZ-CAPDC4

Demand control terminal is available to control 0-50-75-100% of capacities.

\*CZ-CAPDC4 is required as an option

### Flexible Demand Response with the CZ-CAPDC2 \*1

Setting is possible as 0% or in the range from 40 to 100% (in steps of 5%). At the time of shipping, setting has been done to the three steps of 0%, 70% and 100%.

\*1 An outdoor Seri-Para I/O unit (CZ-CAPDC2) is required for demand input signal.

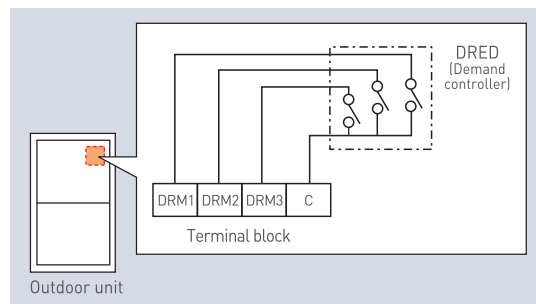

Demand Response Signal	Power Input
DRM 1	0%
DRM 2	50%
DRM 3	100%

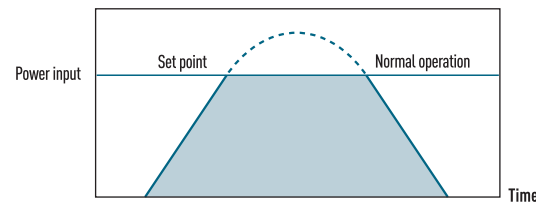

	Power input	
Level 1	100% (Preset)	Possible to change 40-100%
Level 2	70% (Preset)	
Level 3	0% (Always in stop condition)	

## Hi-durability outdoor unit

Corrosion-resistance treated for high resistance to rust and salty air to assure long-lasting performance.

Note: Selecting this unit does not completely eliminate the possibility of rust developing. For details concerning unit installation and maintenance, please consult an authorised dealer.

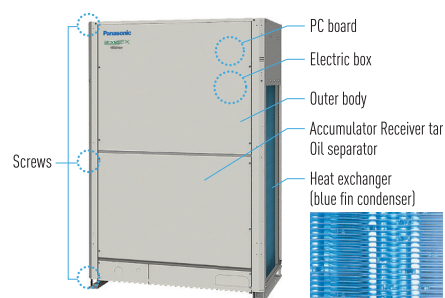



2-WAY FSV-EX ME2 Series HIGH EFFICIENCY COMBINATION MODEL

Appearance																							
HP			8	10	12	14	16	18	20	22	24	26											
Model name			U-8ME2H7	U-10ME2H7	U-12ME2H7	U-14ME2H7	U-16ME2H7	U-18ME2H7HE U-10ME2H7	U-20ME2H7HE U-10ME2H7	U-22ME2H7 U-12ME2H7	U-24ME2H7 U-12ME2H7	U-26ME2H7 U-16ME2H7											
Power supply			380/400/415V/3-phase/50Hz 380/400V/3-phase/60Hz																				
Capacity	Cooling	kW	22.4	28.0	33.5	40.0	45.0	50.0	56.0	61.5	68.0	73.0											
		BTU/h	76,500	95,600	114,300	136,500	153,600	170,600	191,100	209,900	232,100	249,100											
EER / COP	Cooling	W/W	5.30	5.03	4.73	4.56	4.13	5.15	5.05	4.84	4.69	4.42											
		W/W	5.84	5.56	5.38	5.29	5.13	5.71	5.58	5.48	5.31	5.29											
Dimensions	H x W x D	mm	1,842 x 770 x 1,000	1,842 x 770 x 1,000	1,842 x 1,180 x 1,000	1,842 x 1,180 x 1,000	1,842 x 1,180 x 1,000	1,842 x 1,600 x 1,000	1,842 x 1,600 x 1,000	1,842 x 2,010 x 1,000	1,842 x 2,420 x 1,000	1,842 x 2,010 x 1,000											
		kg	210	210	270	315	315	420	420	480	540	525											
Electrical ratings	Cooling	Running current A	7.14 / 6.78 / 6.54	9.62 / 9.14 / 8.81	11.8 / 11.2 / 10.8	15.3 / 14.5 / 14.0	18.4 / 17.5 / 16.8	16.6 / 15.7 / 15.2	19.2 / 18.2 / 17.5	21.4 / 20.4 / 19.6	24.2 / 23.0 / 22.2	28.2 / 26.8 / 25.8											
		Power input kW	4.23	5.57	7.08	8.77	10.9	9.70	11.1	12.7	14.5	16.5											
	Heating	Running current A	7.15 / 6.79 / 6.54	9.68 / 9.20 / 8.86	11.6 / 11.1 / 10.7	14.9 / 14.1 / 13.6	16.6 / 15.8 / 15.2	16.5 / 15.7 / 15.1	19.3 / 18.3 / 17.7	21.3 / 20.2 / 19.5	24.0 / 22.8 / 22.0	26.3 / 25.0 / 24.1											
		Power input kW	4.28	5.67	6.97	8.51	9.75	9.80	11.3	12.6	14.4	15.4											
Starting current	A	1	1	1	2	2	2	2	2	2	3												
Air flow rate	m³/h	13,440	13,440	13,920	13,920	13,920	26,880	26,880	27,360	27,840	27,360												
	L/s	3,733	3,733	3,867	3,867	3,867	7,467	7,466	7,600	7,733	7,600												
Refrigerant amount at shipment	kg	5.6	5.6	8.3	8.3	8.3	11.2	11.2	13.9	16.6	13.9												
External static pressure	Pa	80	80	80	80	80	80	80	80	80	80												
Piping connections	Gas pipe	mm (inches)	Ø19.05 (Ø3/4)	Ø22.22 (Ø7/8)	Ø25.40 (Ø1)	Ø25.40 (Ø1)	Ø28.58 (Ø1-1/8)	Ø28.58 (Ø1-1/8)	Ø28.58 (Ø1-1/8)	Ø28.58 (Ø1-1/8)	Ø28.58 (Ø1-1/8)	Ø31.75 (Ø1-1/4)											
	Liquid pipe	mm (inches)	Ø9.52 (Ø3/8)	Ø9.52 (Ø3/8)	Ø12.70 (Ø1/2)	Ø12.70 (Ø1/2)	Ø12.70 (Ø1/2)	Ø15.88 (Ø5/8)	Ø15.88 (Ø5/8)	Ø15.88 (Ø5/8)	Ø15.88 (Ø5/8)	Ø19.05 (Ø3/4)											
	Balance pipe	mm (inches)	Ø6.35 (Ø1/4)	Ø6.35 (Ø1/4)	Ø6.35 (Ø1/4)	Ø6.35 (Ø1/4)	Ø6.35 (Ø1/4)	Ø6.35 (Ø1/4)	Ø6.35 (Ø1/4)	Ø6.35 (Ø1/4)	Ø6.35 (Ø1/4)	Ø6.35 (Ø1/4)											
Ambient temperature operating range	Cooling: -10°C (DB)~ +52°C (DB). Heating: -25°C (WB)~ +18°C (WB)																						
Sound pressure level	Normal mode	dB (A)	53.0	56.0	57.0	58.0	61.0	58.0	59.0	59.5	60.0	62.5											
	Silent mode (2)	dB (A)	48.0	51.0	52.0	53.0	56.0	53.0	54.0	54.5	55.0	57.5											
Sound power level	Normal mode	dB	74.0	77.0	78.0	79.0	82.0	79.0	80.0	80.5	81.0	83.5											

Appearance												
HP			56	58	60	62	64					
Model name			U-56ME2H7HE U-12ME2H7 U-12ME2H7 U-16ME2H7 U-16ME2H7	U-58ME2H7HE U-10ME2H7 U-16ME2H7 U-16ME2H7 U-16ME2H7	U-60ME2H7HE U-12ME2H7 U-16ME2H7 U-16ME2H7 U-16ME2H7	U-62ME2H7 U-14ME2H7 U-16ME2H7 U-16ME2H7 U-16ME2H7	U-64ME2H7 U-16ME2H7 U-16ME2H7 U-16ME2H7 U-16ME2H7					
Power supply			380/400/415V/3-phase/50Hz 380/400/3-phase/60Hz									
Capacity	Cooling	kW	156.0	162.0	168.0	174.0	180.0					
		BTU/h	532,400	552,900	573,400	593,300	614,300					
EER / COP	Cooling	W/W	4.38	4.27	4.24	4.23	4.13					
		W/W	5.24	5.19	5.15	5.16	5.11					
Dimensions	H x W x D	mm	1,842 x 4,900 x 1,000	1,842 x 4,490 x 1,000	1,842 x 4,900 x 1,000	1,842 x 4,900 x 1,000	1,842 x 4,900 x 1,000					
		kg	1,170	1,155	1,215	1,260	1,260					
Electrical ratings	Cooling	Running current A	60.1 / 57.1 / 55.0	64.0 / 60.8 / 58.6	66.9 / 63.5 / 61.2	70.2 / 66.7 / 64.2	73.6 / 69.9 / 67.4					
		Power input kW	35.6	37.9	39.6	41.1	43.6					
	Heating	Running current A	56.4 / 53.6 / 51.6	59.9 / 56.9 / 54.9	62.7 / 59.5 / 57.4	64.5 / 61.3 / 59.1	67.1 / 63.7 / 61.4					
		Power input kW	33.4	35.1	36.7	37.8	39.3					
Starting current	A	6	7	7	8	8						
Air flow rate	m³/h	55,680	55,200	55,680	55,680	55,680						
	L/s	15,467	15,333	15,467	15,467	15,467						
Refrigerant amount at shipment	kg	33.2	30.5	33.2	33.2	33.2						
External static pressure	Pa	80	80	80	80	80						
Piping connections	Gas pipe	mm (inches)	Ø38.10 (Ø1-1/2)	Ø38.10 (Ø1-1/2)	Ø38.10 (Ø1-1/2)	Ø41.28 (Ø1-5/8)	Ø41.28 (Ø1-5/8)					
	Liquid pipe	mm (inches)	Ø19.05 (Ø3/4)	Ø19.05 (Ø3/4)	Ø19.05 (Ø3/4)	Ø19.05 (Ø3/4)	Ø19.05 (Ø3/4)					
	Balance pipe	mm (inches)	Ø6.35 (Ø1/4)	Ø6.35 (Ø1/4)	Ø6.35 (Ø1/4)	Ø6.35 (Ø1/4)	Ø6.35 (Ø1/4)					
Ambient temperature operating range	Cooling: -10°C (DB)~ +52°C (DB). Heating: -25°C (WB)~ +18°C (WB)											
Sound pressure level	Normal mode	dB (A)	65.5	66.5	66.5	66.5	67.0					
	Silent mode	dB (A)	60.5	61.5	61.5	61.5	62.0					
Sound power level	Normal mode	dB	86.5	87.5	87.5	87.5	88.0					

GLOBALREMARKS

Rated conditions:	Cooling	Heating
Indoor air temperature	27°C DB / 19°C WB	20°C DB
Outdoor air temperature	35°C DB	7°C DB / 6°C WB

These specifications are subject to change without notice.



<b>28</b>	<b>30</b>	<b>32</b>	<b>34</b>	<b>36</b>	<b>38</b>	<b>40</b>	<b>42</b>	<b>44</b>	<b>46</b>	<b>48</b>	<b>50</b>	<b>52</b>	<b>54</b>
U-28ME2H7	U-30ME2H7	U-32ME2H7	U-34ME2H7E	U-36ME2H7E	U-38ME2H7E	U-40ME2H7E	U-42ME2H7	U-44ME2H7	U-46ME2H7	U-48ME2H7	U-50ME2H7E	U-52ME2H7E	U-54ME2H7E
U-12ME2H7 U-16ME2H7	U-14ME2H7 U-16ME2H7	U-16ME2H7 U-16ME2H7	U-10ME2H7 U-12ME2H7 U-12ME2H7	U-12ME2H7 U-12ME2H7 U-12ME2H7	U-10ME2H7 U-12ME2H7 U-16ME2H7	U-12ME2H7 U-12ME2H7 U-16ME2H7	U-10ME2H7 U-16ME2H7 U-16ME2H7	U-12ME2H7 U-16ME2H7 U-16ME2H7	U-14ME2H7 U-16ME2H7 U-16ME2H7	U-16ME2H7 U-16ME2H7 U-16ME2H7	U-10ME2H7 U-12ME2H7 U-12ME2H7 U-16ME2H7	U-12ME2H7 U-12ME2H7 U-12ME2H7 U-16ME2H7	U-10ME2H7 U-12ME2H7 U-16ME2H7 U-16ME2H7

380/400/415V/3-phase/50Hz  
380/400V/3-phase/60Hz

78.5	85.0	90.0	96.0	101.0	107.0	113.0	118.0	124.0	130.0	135.0	140.0	145.0	151.0
267,900	290,100	307,200	327,600	344,700	365,200	385,700	402,700	423,200	443,700	460,800	477,800	494,900	515,400
87.5	95.0	100.0	108.0	113.0	119.0	127.0	132.0	138.0	145.0	150.0	155.0	160.0	169.0
298,600	324,200	341,300	368,600	385,700	406,100	433,400	450,500	471,000	494,900	511,900	529,000	546,100	576,800
4.36	4.31	4.13	4.80	4.72	4.51	4.45	4.31	4.26	4.25	4.13	4.58	4.53	4.40
5.24	5.19	5.13	5.40	5.38	5.31	5.23	5.22	5.19	5.18	5.12	5.36	5.33	5.26
1,842 x 2,420 x 1,000	1,842 x 2,420 x 1,000	1,842 x 2,420 x 1,000	1,842 x 3,250 x 1,000	1,842 x 3,660 x 1,000	1,842 x 3,250 x 1,000	1,842 x 3,660 x 1,000	1,842 x 3,250 x 1,000	1,842 x 3,660 x 1,000	1,842 x 3,660 x 1,000	1,842 x 3,660 x 1,000	1,842 x 4,490 x 1,000	1,842 x 4,900 x 1,000	1,842 x 4,490 x 1,000
585	630	630	750	810	795	855	840	900	945	945	1,065	1,125	1,110
30.4 / 28.9 / 27.8	33.6 / 31.9 / 30.8	36.8 / 35.0 / 33.7	33.8 / 32.1 / 30.9	35.7 / 33.9 / 32.7	40.0 / 38.0 / 36.6	42.4 / 40.3 / 38.8	46.3 / 43.9 / 42.4	49.1 / 46.7 / 45.0	52.2 / 49.6 / 47.8	55.2 / 52.4 / 50.5	51.7 / 49.1 / 47.3	53.4 / 50.8 / 48.9	57.9 / 55.0 / 53.0
18.0	19.7	21.8	20.0	21.4	23.7	25.4	27.4	29.1	30.6	32.7	30.6	32.0	34.3
28.2 / 26.8 / 25.8	31.6 / 30.0 / 28.9	33.3 / 31.6 / 30.5	33.8 / 32.1 / 30.9	35.1 / 33.3 / 32.1	37.8 / 35.9 / 34.6	41.0 / 39.0 / 37.6	43.2 / 41.0 / 39.5	44.9 / 42.7 / 41.1	48.3 / 45.9 / 44.3	50.0 / 47.5 / 45.8	48.8 / 46.3 / 44.7	50.6 / 48.1 / 46.4	54.8 / 52.1 / 50.2
16.7	18.3	19.5	20.0	21.0	22.4	24.3	25.3	26.6	28.0	29.3	28.9	30.0	32.1
3	4	4	3	3	4	4	5	5	6	6	5	5	6
27,840	27,840	27,840	41,280	41,760	41,280	41,760	41,280	41,760	41,760	41,760	55,200	55,680	55,200
7,733	7,733	7,733	11,467	11,600	11,467	11,600	11,467	11,600	11,600	11,600	15,333	15,467	15,333
16.6	16.6	16.6	22.2	24.9	22.2	24.9	22.2	24.9	24.9	24.9	30.5	33.2	30.5
80	80	80	80	80	80	80	80	80	80	80	80	80	80
Ø31.75 (Ø1-1/4)	Ø31.75 (Ø1-1/4)	Ø31.75 (Ø1-1/4)	Ø31.75 (Ø1-1/4)	Ø38.10 (Ø1-1/2)	Ø38.10 (Ø1-1/2)	Ø38.10 (Ø1-1/2)	Ø38.10 (Ø1-1/2)	Ø38.10 (Ø1-1/2)	Ø38.10 (Ø1-1/2)	Ø38.10 (Ø1-1/2)	Ø38.10 (Ø1-1/2)	Ø38.10 (Ø1-1/2)	Ø38.10 (Ø1-1/2)
Ø19.05 (Ø3/4)	Ø19.05 (Ø3/4)	Ø19.05 (Ø3/4)	Ø19.05 (Ø3/4)	Ø19.05 (Ø3/4)	Ø19.05 (Ø3/4)	Ø19.05 (Ø3/4)	Ø19.05 (Ø3/4)	Ø19.05 (Ø3/4)	Ø19.05 (Ø3/4)	Ø19.05 (Ø3/4)	Ø19.05 (Ø3/4)	Ø19.05 (Ø3/4)	Ø19.05 (Ø3/4)
Ø6.35 (Ø1/4)	Ø6.35 (Ø1/4)	Ø6.35 (Ø1/4)	Ø6.35 (Ø1/4)	Ø6.35 (Ø1/4)	Ø6.35 (Ø1/4)	Ø6.35 (Ø1/4)	Ø6.35 (Ø1/4)	Ø6.35 (Ø1/4)	Ø6.35 (Ø1/4)	Ø6.35 (Ø1/4)	Ø6.35 (Ø1/4)	Ø6.35 (Ø1/4)	Ø6.35 (Ø1/4)

Cooling: -10°C (DB)~ +52°C (DB). Heating: -25°C (WB)~ +18°C (WB)

62.5	63.0	64.0	61.5	62.0	63.5	63.5	65.0	65.0	65.0	65.0	66.0	64.5	64.5	65.5
57.5	58.0	59.0	56.5	57.0	58.5	58.5	60.0	60.0	60.0	60.0	61.0	59.5	59.5	60.5
83.5	84.0	85.0	82.5	83.0	84.5	84.5	86.0	86.0	86.0	86.0	87.0	85.5	85.5	86.5

### 8 / 10 HP

According to the installation site, you may choose the setting position in the depth direction of the anchor bolt from A, B or C.

- A: (Installation hole pitch) For removing tube forward
- B: (Installation hole pitch) For removing the downward
- C: (Installation hole pitch)

Top view

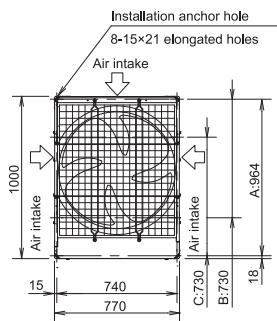

Front view

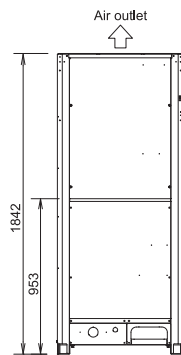

unit: mm

### 12 / 14 / 16 HP

According to the installation site, you may choose the setting position in the depth direction of the anchor bolt from A, B or C.

- A: (Installation hole pitch) For removing tube forward
- B: (Installation hole pitch) For removing the downward
- C: (Installation hole pitch)

Top view

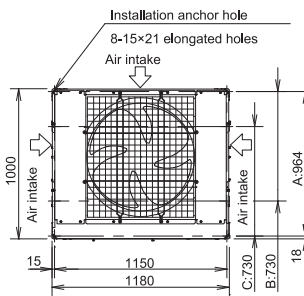



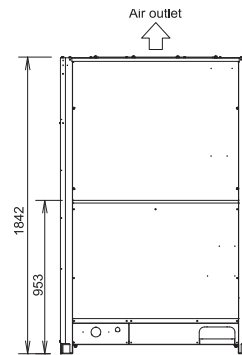





Front view









unit: mm



2-WAY FSV-EX ME2 Series **SPACE SAVING COMBINATION MODEL**

Appearance												
HP			8	10	12	14	16	18	20	22 U-22ME2H7	24 U-24ME2H7	
Model name			U-8ME2H7	U-10ME2H7	U-12ME2H7	U-14ME2H7	U-16ME2H7	U-18ME2H7	U-20ME2H7	U-10ME2H7 U-12ME2H7	U-12ME2H7 U-12ME2H7	
Power supply			380/400/415V/3-phase/50Hz 380/400V/3-phase/60Hz									
Capacity	Cooling	kW	22.4	28.0	33.5	40.0	45.0	50.0	56.0	61.5	68.0	
		BTU/h	76,500	95,600	114,300	136,500	153,600	170,600	191,100	209,900	232,100	
	Heating	kW	25.0	31.5	37.5	45.0	50.0	56.0	63.0	69.0	76.5	
		BTU/h	85,300	107,500	128,000	153,600	170,600	191,100	215,000	235,500	261,100	
EER / COP	Cooling	W/W	5.30	5.03	4.73	4.56	4.13	4.10	3.76	4.84	4.69	
	Heating	W/W	5.84	5.56	5.38	5.29	5.13	5.05	4.60	5.48	5.31	
Dimensions	H x W x D	mm	1,842 x 770 x 1,000	1,842 x 770 x 1,000	1,842 x 1,180 x 1,000	1,842 x 1,180 x 1,000	1,842 x 1,180 x 1,000	1,842 x 1,540 x 1,000	1,842 x 1,540 x 1,000	1,842 x 2,010 x 1,000	1,842 x 2,420 x 1,000	
Net weight		kg	210	270	270	315	315	375	480	540	540	
Electrical ratings	Cooling	Running current	A	7.14 / 6.78 / 6.54	9.62 / 9.14 / 8.81	11.8 / 11.2 / 10.8	15.3 / 14.5 / 14.0	18.4 / 17.5 / 16.8	20.6 / 19.6 / 18.9	24.6 / 23.4 / 22.5	21.4 / 20.4 / 19.6	24.2 / 23.0 / 22.2
		Power input	kW	4.23	5.57	7.08	8.77	10.9	12.2	14.9	12.7	14.5
	Heating	Running current	A	7.15 / 6.79 / 6.54	9.68 / 9.20 / 8.86	11.6 / 11.1 / 10.7	14.9 / 14.1 / 13.6	16.6 / 15.8 / 15.2	18.9 / 18.0 / 17.4	22.9 / 21.7 / 20.9	21.3 / 20.2 / 19.5	24.0 / 22.8 / 22.0
		Power input	kW	4.28	5.67	6.97	8.51	9.75	11.1	13.7	12.6	14.4
Starting current		A	1	1	1	2	2	2	2	2	2	
Air flow rate		m <sup>3</sup> /h	13,440	13,440	13,920	13,920	13,920	24,300	24,300	27,360	27,840	
		L/s	3,733	3,733	3,867	3,867	3,867	6,750	6,750	7,600	7,733	
Refrigerant amount at shipment		kg	5.6	5.6	8.3	8.3	8.3	9.5	9.5	13.9	16.6	
External static pressure		Pa	80	80	80	80	80	80	80	80	80	
Piping connections	Gas pipe	mm (inches)	Ø19.05 (Ø3/4)	Ø22.22 (Ø7/8)	Ø25.40 (Ø1)	Ø25.40 (Ø1)	Ø28.58 (Ø1-1/8)	Ø28.58 (Ø1-1/8)	Ø28.58 (Ø1-1/8)	Ø28.58 (Ø1-1/8)	Ø28.58 (Ø1-1/8)	
	Liquid pipe	mm (inches)	Ø9.52 (Ø3/8)	Ø9.52 (Ø3/8)	Ø12.70 (Ø1/2)	Ø12.70 (Ø1/2)	Ø12.70 (Ø1/2)	Ø15.88 (Ø5/8)	Ø15.88 (Ø5/8)	Ø15.88 (Ø5/8)	Ø15.88 (Ø5/8)	
	Balance pipe	mm (inches)	Ø6.35 (Ø1/4)	Ø6.35 (Ø1/4)	Ø6.35 (Ø1/4)	Ø6.35 (Ø1/4)	Ø6.35 (Ø1/4)	Ø6.35 (Ø1/4)	Ø6.35 (Ø1/4)	Ø6.35 (Ø1/4)	Ø6.35 (Ø1/4)	
Ambient temperature operating range			Cooling: -10°C (DB)~ +52°C (DB). Heating: -25°C (WB)~ +18°C (WB)									
Sound pressure level	Normal mode	dB (A)	53.0	56.0	57.0	58.0	61.0	59.0	59.0	59.5	60.0	
	Silent mode (2)	dB (A)	48.0	51.0	52.0	53.0	56.0	54.0	54.0	54.5	55.0	
Sound power level	Normal mode	dB	74.0	77.0	78.0	79.0	82.0	80.0	80.0	80.5	81.0	

Appearance												
HP			50 U-50ME2H7SP	52 U-52ME2H7SP	54 U-54ME2H7SP	56 U-56ME2H7SP	58 U-58ME2H7SP	60 U-60ME2H7SP	62 U-62ME2H7	64 U-64ME2H7	66 U-66ME2H7SP	
Model name			U-14ME2H7 U-16ME2H7 U-20ME2H7	U-16ME2H7 U-16ME2H7 U-20ME2H7	U-14ME2H7 U-20ME2H7 U-20ME2H7	U-16ME2H7 U-20ME2H7 U-20ME2H7	U-18ME2H7 U-20ME2H7 U-20ME2H7	U-20ME2H7 U-20ME2H7 U-20ME2H7	U-14ME2H7 U-16ME2H7 U-16ME2H7 U-16ME2H7	U-16ME2H7 U-16ME2H7 U-16ME2H7 U-16ME2H7	U-10ME2H7 U-16ME2H7 U-20ME2H7 U-20ME2H7	
Power supply			380/400/415V/3-phase/50Hz 380/400/3-phase/60Hz									
Capacity	Cooling	kW	140.0	145.0	151.0	156.0	162.0	168.0	174.0	180.0	185.0	
		BTU/h	477,800	494,900	515,400	532,400	552,900	573,400	593,900	614,300	631,400	
	Heating	kW	155.0	160.0	169.0	175.0	182.0	189.0	195.0	201.0	207.0	
		BTU/h	529,000	546,100	576,800	597,300	621,200	645,100	665,500	686,000	706,500	
EER / COP	Cooling	W/W	4.09	3.99	3.95	3.87	3.86	3.76	4.23	4.13	4.00	
	Heating	W/W	5.00	4.95	4.79	4.76	4.73	4.60	5.16	5.11	4.85	
Dimensions	H x W x D	mm	1,842 x 4,020 x 1,000	1,842 x 4,020 x 1,000	1,842 x 4,380 x 1,000	1,842 x 4,380 x 1,000	1,842 x 4,740 x 1,000	1,842 x 4,740 x 1,000	1,842 x 4,900 x 1,000	1,842 x 4,900 x 1,000	1,842 x 5,210 x 1,000	
Net weight		kg	1,005	1,005	1,065	1,065	1,125	1,125	1,260	1,260	1,275	
Electrical ratings	Cooling	Running current	A	57.7 / 54.8 / 52.9	60.6 / 57.6 / 55.5	63.8 / 60.6 / 58.4	67.3 / 63.9 / 61.6	70.1 / 66.6 / 64.2	73.8 / 70.1 / 67.6	70.2 / 66.7 / 64.2	73.6 / 69.9 / 67.4	77.3 / 73.4 / 70.8
		Power input	kW	34.2	36.3	38.2	40.3	42.0	44.7	41.1	43.6	46.3
	Heating	Running current	A	52.9 / 50.3 / 48.5	54.5 / 51.8 / 49.9	59.6 / 56.6 / 54.6	62.1 / 59.0 / 56.9	65.0 / 61.7 / 59.5	68.6 / 65.2 / 62.8	64.5 / 61.3 / 59.1	67.1 / 63.7 / 61.4	72.1 / 68.5 / 66.0
		Power input	kW	31.0	32.3	35.3	36.8	38.5	41.1	37.8	39.3	42.7
Starting current		A	6	6	6	6	6	6	8	8	7	
Air flow rate		m <sup>3</sup> /h	52,140	52,140	62,520	62,520	72,900	72,900	55,680	55,680	75,960	
		L/s	14,483	14,483	17,366	17,366	20,250	20,250	15,467	15,467	21,100	
Refrigerant amount at shipment		kg	26.1	26.1	27.3	27.3	28.5	28.5	33.2	33.2	32.9	
External static pressure		Pa	80	80	80	80	80	80	80	80	80	
Piping connections	Gas pipe	mm (inches)	Ø38.10 (Ø1-1/2)	Ø38.10 (Ø1-1/2)	Ø38.10 (Ø1-1/2)	Ø38.10 (Ø1-1/2)	Ø38.10 (Ø1-1/2)	Ø38.10 (Ø1-1/2)	Ø41.28 (Ø1-5/8)	Ø41.28 (Ø1-5/8)	Ø41.28 (Ø1-5/8)	
	Liquid pipe	mm (inches)	Ø19.05 (Ø3/4)	Ø19.05 (Ø3/4)	Ø19.05 (Ø3/4)	Ø19.05 (Ø3/4)	Ø19.05 (Ø3/4)	Ø19.05 (Ø3/4)	Ø19.05 (Ø3/4)	Ø19.05 (Ø3/4)	Ø19.05 (Ø3/4)	
	Balance pipe	mm (inches)	Ø6.35 (Ø1/4)	Ø6.35 (Ø1/4)	Ø6.35 (Ø1/4)	Ø6.35 (Ø1/4)	Ø6.35 (Ø1/4)	Ø6.35 (Ø1/4)	Ø6.35 (Ø1/4)	Ø6.35 (Ø1/4)	Ø6.35 (Ø1/4)	
Ambient temperature operating range			Cooling: -10°C (DB)~ +52°C (DB). Heating: -25°C (WB)~ +18°C (WB)									
Sound pressure level	Normal mode	dB (A)	64.5	65.5	63.5	64.5	64.0	64.0	66.5	67.0	65.5	
	Silent mode	dB (A)	59.5	60.5	58.5	59.5	59.0	59.0	61.5	62.0	60.5	
Sound power level	Normal mode	dB	85.5	86.5	84.5	85.5	85.0	85.0	87.5	88.0	86.5	

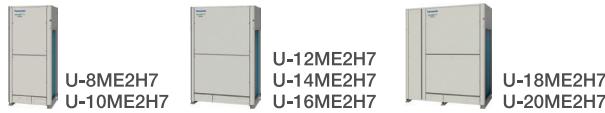

<b>26</b>	<b>28</b>	<b>30</b>	<b>32</b>	<b>34</b>	<b>36</b>	<b>38</b>	<b>40</b>	<b>42</b>	<b>44</b>	<b>46</b>	<b>48</b>
U-26ME2H7	U-28ME2H7	U-30ME2H7	U-32ME2H7	U-34ME2H7SP	U-36ME2H7SP	U-38ME2H7SP	U-40ME2H7SP	U-42ME2H7	U-44ME2H7	U-46ME2H7	U-48ME2H7
U-10ME2H7 U-16ME2H7	U-12ME2H7 U-16ME2H7	U-14ME2H7 U-16ME2H7	U-16ME2H7 U-16ME2H7	U-14ME2H7 U-20ME2H7	U-16ME2H7 U-20ME2H7	U-18ME2H7 U-20ME2H7	U-20ME2H7 U-20ME2H7	U-10ME2H7 U-16ME2H7 U-16ME2H7	U-12ME2H7 U-16ME2H7 U-16ME2H7	U-14ME2H7 U-16ME2H7 U-16ME2H7	U-16ME2H7 U-16ME2H7 U-16ME2H7

380/400/415V/3-phase/50Hz  
380/400V/3-phase/60Hz

73.0	78.5	85.0	90.0	96.0	101.0	107.0	113.0	118.0	124.0	130.0	135.0
249,100	267,900	290,100	307,200	327,600	344,700	365,200	385,700	402,700	423,200	443,700	460,800
81.5	87.5	95.0	100.0	108.0	113.0	119.0	127.0	132.0	138.0	145.0	150.0
278,200	298,600	324,200	341,300	368,600	385,700	406,100	433,400	450,500	471,000	494,900	511,900
4.42	4.36	4.31	4.13	4.05	3.91	3.89	3.74	4.31	4.26	4.25	4.13
5.29	5.24	5.19	5.13	4.86	4.81	4.80	4.58	5.22	5.19	5.18	5.12
1,842 x 2,010 x 1,000	1,842 x 2,420 x 1,000	1,842 x 2,420 x 1,000	1,842 x 2,420 x 1,000	1,842 x 2,780 x 1,000	1,842 x 2,780 x 1,000	1,842 x 3,140 x 1,000	1,842 x 3,140 x 1,000	1,842 x 3,250 x 1,000	1,842 x 3,660 x 1,000	1,842 x 3,660 x 1,000	1,842 x 3,660 x 1,000
525	585	630	630	690	690	750	750	840	900	945	945
28.2 / 26.8 / 25.8	30.4 / 28.9 / 27.8	33.6 / 31.9 / 30.8	36.8 / 35.0 / 33.7	40.0 / 38.0 / 36.6	43.1 / 40.9 / 39.4	45.9 / 43.6 / 42.0	49.9 / 47.4 / 45.7	46.3 / 43.9 / 42.4	49.1 / 46.7 / 45.0	52.2 / 49.6 / 47.8	55.2 / 52.4 / 50.5
16.5	18.0	19.7	21.8	23.7	25.8	27.5	30.2	27.4	29.1	30.6	32.7
26.3 / 25.0 / 24.1	28.2 / 26.8 / 25.8	31.6 / 30.0 / 28.9	33.3 / 31.6 / 30.5	37.9 / 36.0 / 34.7	39.7 / 37.7 / 36.3	41.9 / 39.8 / 38.3	46.2 / 43.9 / 42.3	43.2 / 41.0 / 39.5	44.9 / 42.7 / 41.1	48.3 / 45.9 / 44.3	50.0 / 47.5 / 45.8
15.4	16.7	18.3	19.5	22.2	23.5	24.8	27.7	25.3	26.6	28.0	29.3
3	3	4	4	4	4	4	4	5	5	6	6
27,360	27,840	27,840	27,840	38,220	38,220	48,600	48,600	41,280	41,760	41,760	41,760
7,600	7,733	7,733	7,733	10,617	10,617	13,500	13,500	11,467	11,600	11,600	11,600
13.9	16.6	16.6	16.6	17.8	17.8	19.0	19.0	22.2	24.9	24.9	24.9
80	80	80	80	80	80	80	80	80	80	80	80
Ø31.75 (Ø1-1/4)	Ø31.75 (Ø1-1/4)	Ø31.75 (Ø1-1/4)	Ø31.75 (Ø1-1/4)	Ø31.75 (Ø1-1/4)	Ø38.10 (Ø1-1/2)	Ø38.10 (Ø1-1/2)	Ø38.10 (Ø1-1/2)	Ø38.10 (Ø1-1/2)	Ø38.10 (Ø1-1/2)	Ø38.10 (Ø1-1/2)	Ø38.10 (Ø1-1/2)
Ø19.05 (Ø3/4)	Ø19.05 (Ø3/4)	Ø19.05 (Ø3/4)	Ø19.05 (Ø3/4)	Ø19.05 (Ø3/4)	Ø19.05 (Ø3/4)	Ø19.05 (Ø3/4)	Ø19.05 (Ø3/4)	Ø19.05 (Ø3/4)	Ø19.05 (Ø3/4)	Ø19.05 (Ø3/4)	Ø19.05 (Ø3/4)
Ø6.35 (Ø1/4)	Ø6.35 (Ø1/4)	Ø6.35 (Ø1/4)	Ø6.35 (Ø1/4)	Ø6.35 (Ø1/4)	Ø6.35 (Ø1/4)	Ø6.35 (Ø1/4)	Ø6.35 (Ø1/4)	Ø6.35 (Ø1/4)	Ø6.35 (Ø1/4)	Ø6.35 (Ø1/4)	Ø6.35 (Ø1/4)

Cooling: -10°C (DB)~ +52°C (DB). Heating: -25°C (WB)~ +18°C (WB)

62.5	62.5	63.0	64.0	61.5	63.5	62.0	62.0	65.0	65.0	65.0	66.0
57.5	57.5	58.0	59.0	56.5	58.5	57.0	57.0	60.0	60.0	60.0	61.0
83.5	83.5	84.0	85.0	82.5	84.5	83.0	83.0	86.0	86.0	86.0	87.0

<b>68</b>	<b>70</b>	<b>72</b>	<b>74</b>	<b>76</b>	<b>78</b>	<b>80</b>
U-68ME2H7SP	U-70ME2H7SP	U-72ME2H7SP	U-74ME2H7SP	U-76ME2H7SP	U-78ME2H7SP	U-80ME2H7SP
U-12ME2H7 U-16ME2H7 U-20ME2H7 U-20ME2H7	U-10ME2H7 U-20ME2H7 U-20ME2H7 U-20ME2H7	U-16ME2H7 U-16ME2H7 U-20ME2H7 U-20ME2H7	U-16ME2H7 U-18ME2H7 U-20ME2H7 U-20ME2H7	U-16ME2H7 U-20ME2H7 U-20ME2H7 U-20ME2H7	U-18ME2H7 U-20ME2H7 U-20ME2H7 U-20ME2H7	U-20ME2H7 U-20ME2H7 U-20ME2H7 U-20ME2H7

380/400/415V/3-phase/50Hz  
380/400V/3-phase/60Hz

190.0	196.0	202.0	208.0	213.0	219.0	224.0
648,500	668,900	689,400	709,900	727,000	747,400	764,500
213.0	219.0	226.0	233.0	239.0	245.0	252.0
727,000	747,400	771,300	795,200	815,700	836,200	860,100
3.99	3.90	3.91	3.90	3.83	3.82	3.76
4.84	4.73	4.82	4.79	4.70	4.69	4.60
1,842 x 5,620 x 1,000	1,842 x 5,570 x 1,000	1,842 x 5,620 x 1,000	1,842 x 5,980 x 1,000	1,842 x 5,980 x 1,000	1,842 x 6,340 x 1,000	1,842 x 6,340 x 1,000
1,335	1,335	1,380	1,440	1,440	1,500	1,500
79.5 / 75.5 / 72.8	84.0 / 79.8 / 76.9	86.2 / 81.8 / 78.9	89.0 / 84.5 / 81.5	91.8 / 87.2 / 84.1	94.6 / 89.9 / 86.6	98.4 / 93.5 / 90.1
47.6	50.3	51.6	53.3	55.6	57.3	59.6
73.5 / 69.8 / 67.3	77.3 / 73.4 / 70.8	79.2 / 75.2 / 72.5	82.0 / 77.9 / 75.1	85.0 / 80.7 / 77.8	87.2 / 82.8 / 79.8	91.5 / 86.9 / 83.8
44.0	46.3	46.9	48.6	50.9	52.2	54.8
7	7	8	8	8	8	8
76,440	86,340	76,440	86,820	86,820	97,200	97,200
21,233	23,983	21,233	24,117	24,117	27,000	27,000
35.6	34.1	35.6	36.8	36.8	38.0	38.0
80	80	80	80	80	80	80
Ø41.28 (Ø1-5/8)	Ø41.28 (Ø1-5/8)	Ø44.45 (Ø1-3/4)	Ø44.45 (Ø1-3/4)	Ø44.45 (Ø1-3/4)	Ø44.45 (Ø1-3/4)	Ø44.45 (Ø1-3/4)
Ø22.22 (Ø7/8)	Ø22.22 (Ø7/8)	Ø22.22 (Ø7/8)	Ø22.22 (Ø7/8)	Ø22.22 (Ø7/8)	Ø22.22 (Ø7/8)	Ø22.22 (Ø7/8)
Ø6.35 (Ø1/4)	Ø6.35 (Ø1/4)	Ø6.35 (Ø1/4)	Ø6.35 (Ø1/4)	Ø6.35 (Ø1/4)	Ø6.35 (Ø1/4)	Ø6.35 (Ø1/4)

Cooling: -10°C (DB)~ +52°C (DB). Heating: -25°C (WB)~ +18°C (WB)

65.5	64.5	66.5	66.0	66.0	65.0	65.0
60.5	59.5	61.5	61.0	61.0	60.0	60.0
86.5	85.5	87.5	87.0	87.0	86.0	86.0

GLOBALREMARKS

Rated conditions:	Cooling	Heating
Indoor air temperature	27°C DB / 19°C WB	20°C DB
Outdoor air temperature	35°C DB	7°C DB / 6°C WB

These specifications are subject to change without notice.



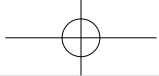

## 2-WAY FSV-EX ME2 Series **SPACE SAVING COMBINATION MODEL**

### 8 / 10 HP

According to the installation site, you may choose the setting position in the depth direction of the anchor bolt from A, B or C.

- A: (Installation hole pitch) For removing tube forward
- B: (Installation hole pitch) For removing the downward
- C: (Installation hole pitch)

### 12 / 14 / 16 HP

According to the installation site, you may choose the setting position in the depth direction of the anchor bolt from A, B or C.

- A: (Installation hole pitch) For removing tube forward
- B: (Installation hole pitch) For removing the downward
- C: (Installation hole pitch)

Top view

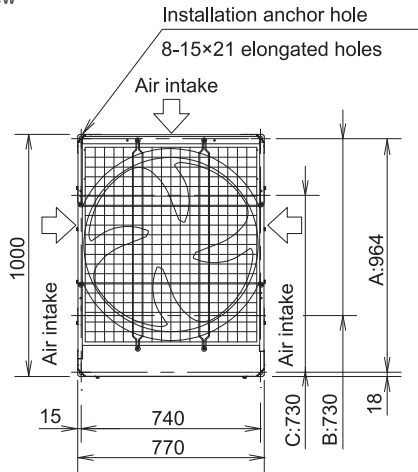

Top view

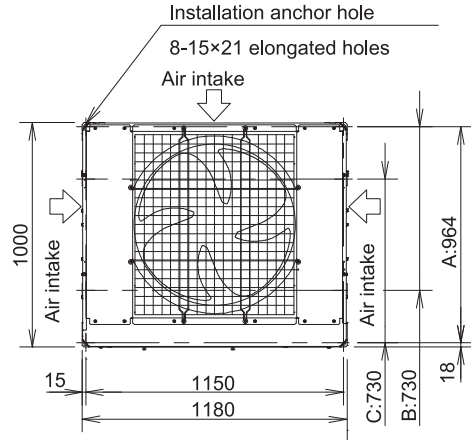

Front view

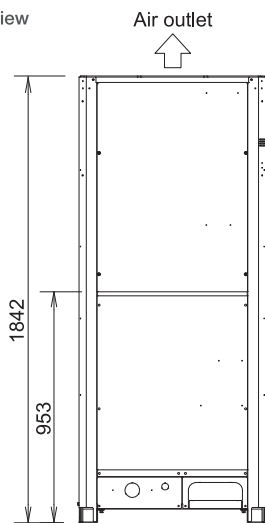

unit: mm

Front view

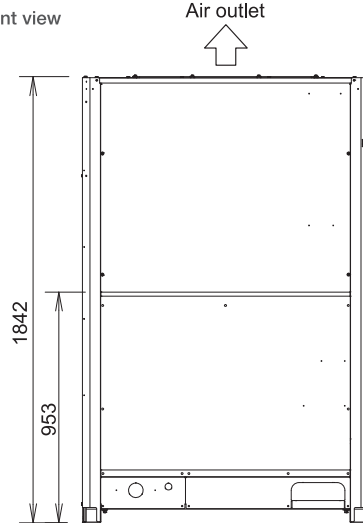

unit: mm

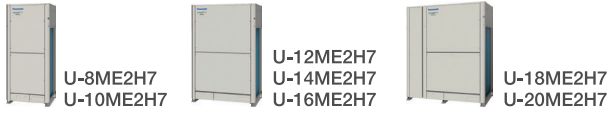

## 18 / 20 HP

According to the installation site, you may choose the setting position in the depth direction of the anchor bolt from A, B or C.

- A: (Installation hole pitch) For removing tube forward
- B: (Installation hole pitch) For removing the downward
- C: (Installation hole pitch)

Top view

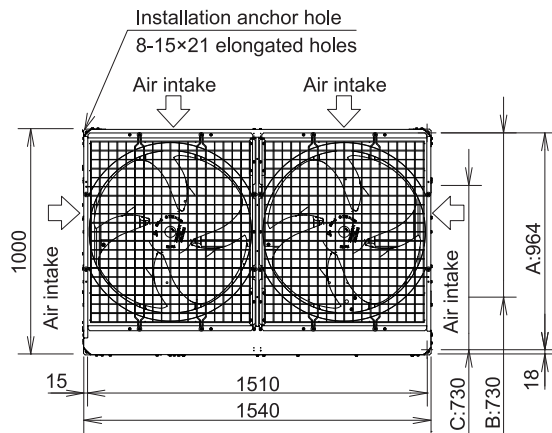

Front view

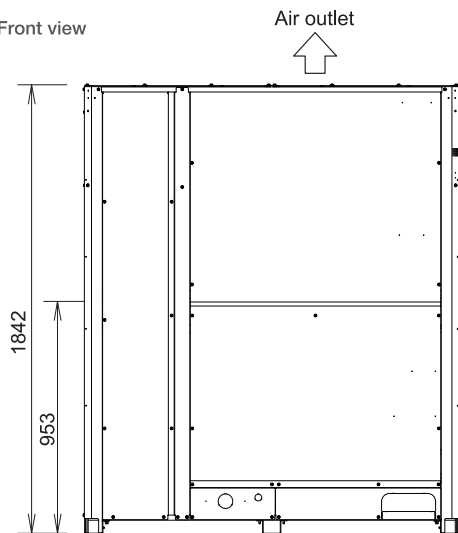

unit: mm



# Piping Design

Select installation locations so that the lengths and sizes of refrigerant piping are within the allowable ranges shown in the figure below.

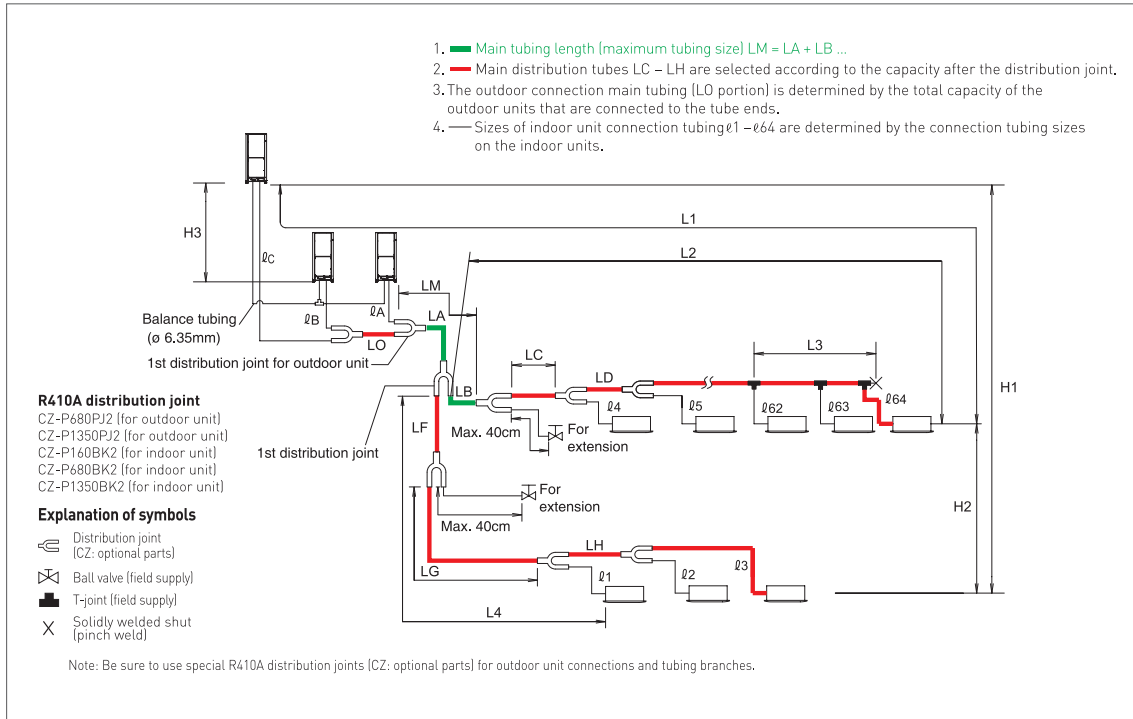

## Ranges that apply to refrigerant piping lengths and to differences in installation heights

Items	Mark	Contents	Length (m)
Allowable tubing length	L1	Max. tubing length	Actual length $\leq 200^{*2}$
			Equivalent length $\leq 210^{*2}$
	$\Delta L (L2-L4)$	Difference between max. length and min. length from the 1st distribution joint	$\leq 50^{*5}$
	LM	Max. length of main tubing (at maximum size) * Even after 1st distribution joint, LM is allowed if at maximum tubing length.	$\leq 50^{*3}$
	$\phi 1, \phi 2 - \phi 64$	Max. length of each distribution tube	$\leq 50^{*7}$
	$L1 + \phi 1 + \phi 2 - \phi 63 + \phi A + \phi B + LF + LG + LH$	Total max. tubing length including length of each distribution tube (only liquid tubing)	$\leq 1000$
Allowable elevation difference	$\phi A, \phi B + LO, \phi C + LO$	Maximum tubing length from outdoor's 1st distribution joint to each outdoor unit	$\leq 10$
	H1	When outdoor unit is installed higher than indoor unit	$\leq 50$
	H2	When outdoor unit is installed lower than indoor unit	$\leq 40$
Allowable length of joint tubing	L3	Max. difference between indoor units	$\leq 15^{*6}$
		Max. difference between outdoor units	$\leq 4$
Allowable length of joint tubing	L3	T-joint tubing (field-supply); Max. tubing length between the first T-joint and solidly welded-shut end point	$\leq 2$

L = Length, H = Height

NOTE

- The outdoor connection main tubing (LO portion) is determined by the total capacity of the outdoor units that are connected to the tube ends.
- If the longest tubing length (L1) exceeds 90 m (equivalent length), increase the sizes of the main tubes (LM) by 1 rank for gas tubes and liquid tubes. Use a field supply reducer. Select the tube size from the table of main tubing sizes (Table 3) and from the table of refrigerant tubing sizes (Table 8) on the second following page.
- If the longest main tubing length (LM) exceeds 50 m, increase the main tubing size at the portion before 50 m by 1 rank for the gas tubes. Use a field supply reducer. Determine the length less than the limitation of allowable maximum tubing length. For the portion that exceeds 50 m, set based on the main tubing size (LA) listed in Table 3.
- If the size of the existing tubing is already larger than the standard tubing size, it is not necessary to further increase the size.  
 \* If the existing tubing is used, and the amount of on-site refrigerant charge exceeds the value listed below, then change the size of the tubing to reduce the amount of refrigerant.  
 Total amount of refrigerant for the system with 1 outdoor unit: 50 kg  
 Total amount of refrigerant for the system with 2 outdoor units: 80 kg  
 Total amount of refrigerant for the system with 3 outdoor units or 4 outdoor units: 105 kg
- When the tubing length exceeds 40 m, increase a longer liquid or gas tubing by 1 rank. Refer to the Technical Data for the details.
- If the total distribution tubing length exceeds 500m, maximum allowable elevation difference (H2) between the indoor units is calculated by the following formula. Make sure the indoor unit's actual elevation difference should fall within the figure calculated as follows.  
 Unit of account (meter):  $15 \times (2 - \text{total tubing length(m)} \div 500)$
- If any of the tubing length exceeds 30m, increase the size of the liquid and gas tubes by 1 rank.

### Necessary amount of additional refrigerant charge per outdoor unit

U-8ME2H7(E)	U-10ME2H7(E)	U-12ME2H7(E)	U-14ME2H7(E)	U-16ME2H7(E)	U-18ME2H7(E)	U-20ME2H7(E)
5.5kg	5.5kg	7.0 kg	7.0 kg	7.0 kg	7.0 kg	7.0 kg

### System limitations

Max. No. allowable connected outdoor units	4 *2
Max. capacity allowable connected outdoor units	224 kW (80 HP)
Max. connectable indoor units	64 *1
Max. allowable indoor/outdoor capacity ratio	50-130 % *3

\*1: In the case of 38 HP or smaller units, the number is limited by the total capacity of the connected indoor units.

\*2: Up to 4 units can be connected if the system has been extended.

\*3: If the following conditions are satisfied, the effective range is above 130 % and below 200 %.

- i) Obey the limited number of connectable indoor units.
- ii) The lower limit of operating range for heating outdoor temperature is limited to -10°CWB (standard -25°CWB).
- iii) Simultaneous operation is limited to less than 130 % of connectable indoor units.

### Additional refrigerant charge

Liquid tubing size mm (inches)	Amount of refrigerant charge/m (g/m)
ø6.35 (ø1/4)	26
ø9.52 (ø3/8)	56
ø12.7 (ø1/2)	128
ø15.88 (ø5/8)	185
ø19.05 (ø3/4)	259
ø22.22 (ø7/8)	366
ø25.4 (ø1)	490

### Refrigerant piping (Existing piping can be used.)

#### High Efficiency Combination Model

Piping size (mm)			
Material Temper - O		Material Temper - 1/2 H, H	
ø6.35	t 0.8	ø22.22	t 1.0
ø9.52	t 0.8	ø25.4	t 1.0
ø12.7	t 0.8	ø28.58	t 1.0
ø15.88	t 1.0	ø31.75	t 1.1
ø19.05	t 1.2	ø38.1	over t 1.35
		ø41.28	over t 1.45
		ø44.45	over t1.55

#### Space Saving Combination Model

Piping size (mm)			
Material Temper - O		Material Temper - 1/2 H, H	
ø6.35	t 0.8	ø22.22	t 1.0
ø9.52	t 0.8	ø25.4	t 1.0
ø12.7	t 0.8	ø28.58	t 1.0
ø15.88	t 1.0	ø31.75	t 1.1
ø19.05	t 1.2	ø38.1	over t 1.35
		ø41.28	over t 1.45
		ø44.45	over t1.55
		ø50.8	over t1.8

\* When bending the tubes, use a bending radius that is at least 4 times the outer diameter of the tubes. In addition, take sufficient care to avoid crushing or damaging the tubes when bending them.





# Refrigerant Branch Pipes (optional accessories) for 2-WAY ME2 Series

## Optional Distribution Joint Kits

See the installation instructions packaged with the distribution joint kit for the installation procedure.

\* In case the total capacity of indoor units connected after distribution exceeds the total capacity of the outdoor units, select the distribution tubing size for the total capacity of the outdoor units.

Model name	Cooling capacity after distribution	Remarks
1. CZ-P680PJ2	68.0 kW or less	For outdoor unit
2. CZ-P1350PJ2	more than 68.0 kW	For outdoor unit
3. CZ-P160BK2	22.4 kW or less *	For indoor unit
4. CZ-P680BK2	68.0 kW or less *	For indoor unit
5. CZ-P1350BK2	more than 68.0 kW *	For indoor unit

## Tubing size (with thermal insulation)

### 1. CZ-P680PJ2

For outdoor unit (Capacity after distribution joint is 68.0 kW or less.)

#### GAS TUBING

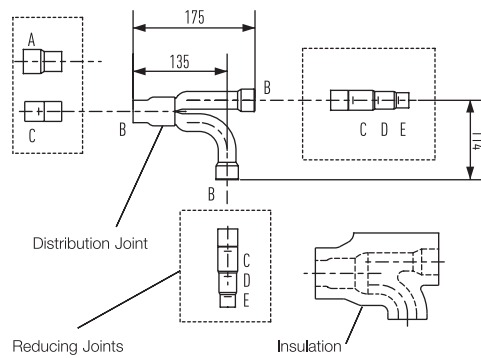

#### LIQUID TUBING

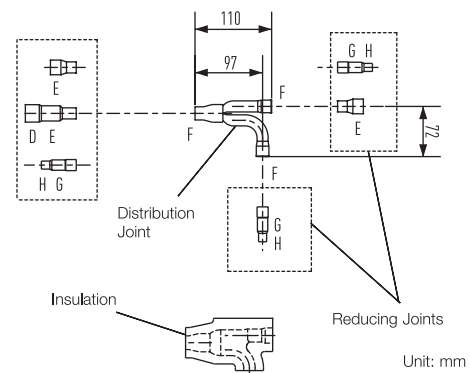

Size of connection point on each part (Shown are inside diameters of tubing)								
Size	Part A	Part B	Part C	Part D	Part E	Part F	Part G	Part H
Dimension (mm)	ø31.75	ø28.58	ø25.40	ø22.22	ø19.05	ø15.88	ø12.70	ø9.52
Dimension (inches)	Ø1-1/4	Ø1-1/8	Ø1	Ø7/8	Ø3/4	Ø5/8	Ø1/2	Ø3/8

### 2. CZ-P1350PJ2

For outdoor unit (Capacity after distribution joint is more than 68.0 kW.)

#### GAS TUBING

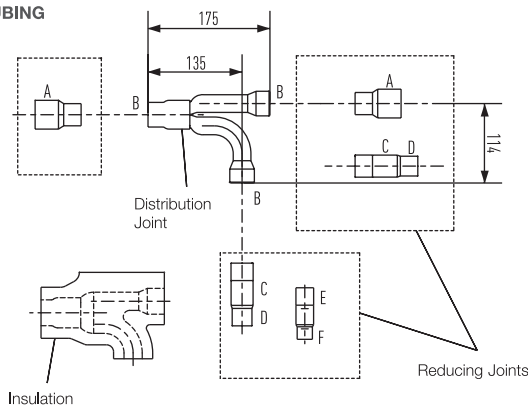

#### LIQUID TUBING

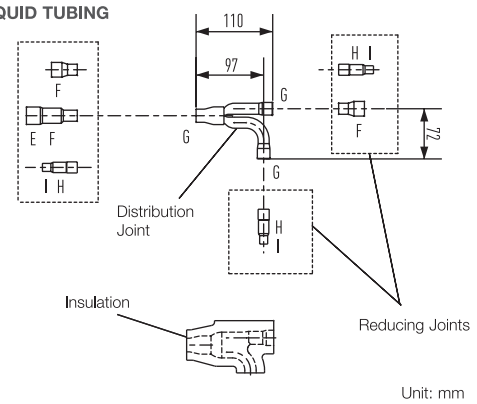

Size of connection point on each part (Shown are inside diameters of tubing)									
Size	Part A	Part B	Part C	Part D	Part E	Part F	Part G	Part H	Part I
Dimension (mm)	ø38.10	ø31.75	ø28.58	ø25.40	ø22.22	ø19.05	ø15.88	ø12.70	ø9.52
Dimension (inches)	Ø1-1/2	Ø1-1/4	Ø1-1/8	Ø1	Ø7/8	Ø3/4	Ø5/8	Ø1/2	Ø3/8

\* If the tube diameter is more than ø38.1, use field-supply reducer.

### 3. CZ-P160BK2

Use: For indoor unit (Capacity after distribution joint is 22.4 kW or less.)\*

#### GAS TUBING

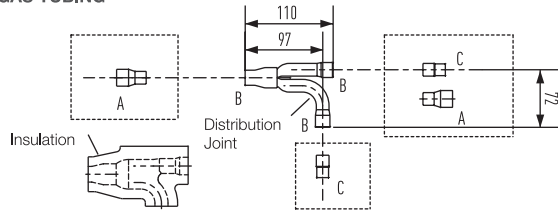

#### LIQUID TUBING

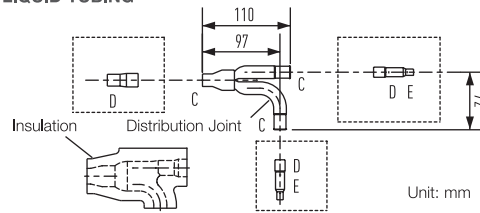

Unit: mm

Size of connection point on each part (Shown are inside diameters of tubing)					
Size	Part A	Part B	Part C	Part D	Part E
Dimension (mm)	Ø19.05	Ø15.88	Ø12.70	Ø9.52	Ø6.35
(inches)	Ø3/4	Ø5/8	Ø1/2	Ø3/8	Ø1/4

### 4. CZ-P680BK2

Use: For indoor unit (Capacity after distribution joint is more than 22.4 kW and no more than 68.0 kW.)\*

#### GAS TUBING

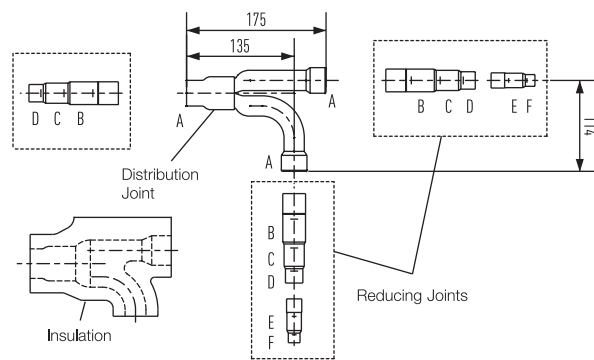

#### LIQUID TUBING

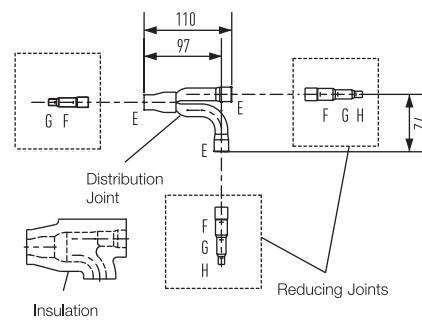

Unit: mm

Size of connection point on each part (Shown are inside diameters of tubing)								
Size	Part A	Part B	Part C	Part D	Part E	Part F	Part G	Part H
Dimension (mm)	Ø28.58	Ø25.40	Ø22.22	Ø19.05	Ø15.88	Ø12.70	Ø9.52	Ø6.35
(inches)	Ø1-1/8	Ø1	Ø7/8	Ø3/4	Ø5/8	Ø1/2	Ø3/8	Ø1/4

### 5. CZ-P1350BK2

Use: For indoor unit (Capacity after distribution joint is more than 68.0 kW.)\*

#### GAS TUBING

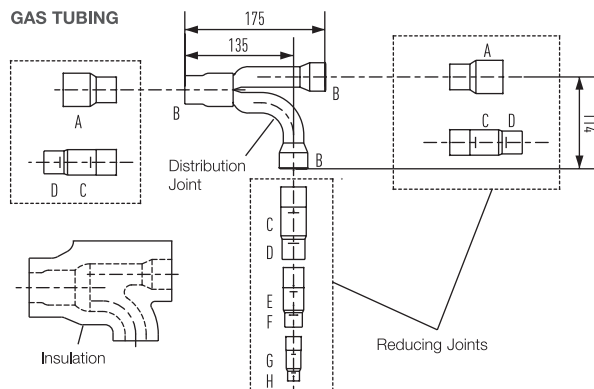

#### LIQUID TUBING

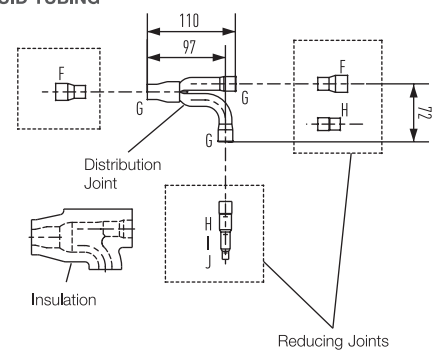

Unit: mm

Size of connection point on each part (Shown are inside diameters of tubing)										
Size	Part A	Part B	Part C	Part D	Part E	Part F	Part G	Part H	Part I	Part J
Dimension (mm)	Ø38.10	Ø31.75	Ø28.58	Ø25.40	Ø22.22	Ø19.05	Ø15.88	Ø12.70	Ø9.52	Ø6.35
(inches)	Ø1-1/2	Ø1-1/4	Ø1-1/8	Ø1	Ø7/8	Ø3/4	Ø5/8	Ø1/2	Ø3/8	Ø1/4

\*If the tube diameter is more than ø38.1, use field-supply reducer.

\* In case the total capacity of indoor units connected after distribution exceeds the total capacity of the outdoor units, select the distribution tubing size for the total capacity of the outdoor units.



# 2-WAY Mini-FSV LE Series

# High External Static Pressure 35Pa

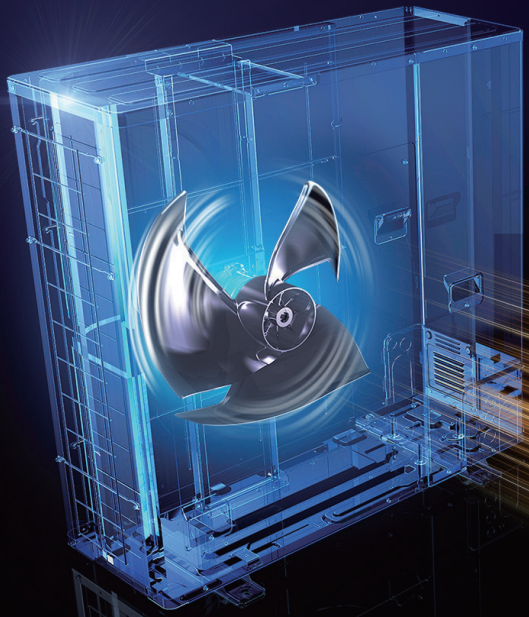

## High external static pressure 35Pa

LE1 LE2

When unit is installed on a narrow balcony and exposed to the sun, the fence at the front side would restrict hot air from being discharged. Heat accumulated in an enclosure can cause over-heating. This could potentially result in damage or shorten the product's life span. A high external static pressure sends the air further away from the outdoor unit and through the fence. This provides better air circulation and distribution.



### Previous model - Low pressure

When the pressure is low, hot air will accumulate in the unit thus affecting its work performance and of the unit above it as well.

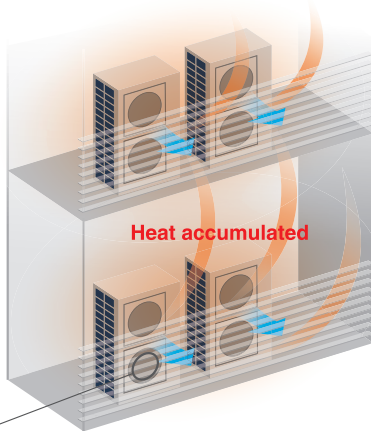

### Previous fan

High electrostatic pressure disrupted the airflow of the previous fan, lowering the air pressure and preventing hot air from being discharged far enough.



### LE series - High pressure

But with a high pressure of 35Pa, hot air is sent further away preventing overheating inside the outdoor unit enclosure.

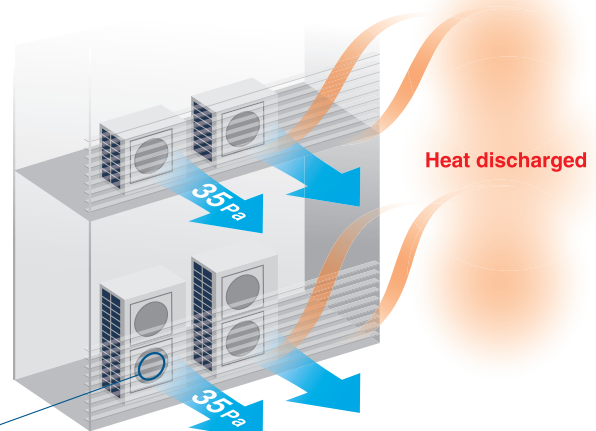

### LE series fan

The new LE Series fan has ribs extending near the blade tips, in a structure that resists deformation. During high electrostatic pressure, this blade shape suppresses disruptions in the airflow, and a high air pressure of 35 Pa discharges the hot air a sufficient distance.



Long piping design length for greater design flexibility

LE1 LE2

Adaptable to various building types and sizes

Actual piping length **150m**  
(equivalent piping length **175m**)

Max. total piping length: **300m**

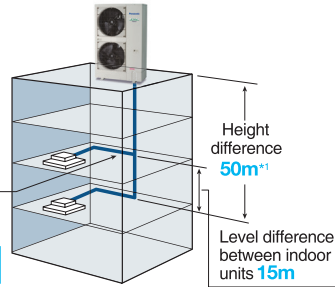

LE1

Actual piping length **150m**  
(equivalent piping length **175m**)

Max. total piping length: **180m**

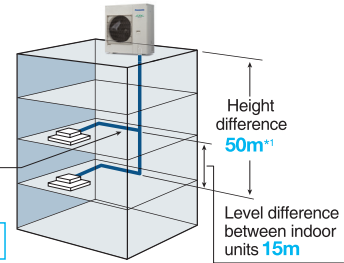

LE2

\*1: 40m if the outdoor unit is below the indoor unit.

Refrigerant chargeless up to 50m

LE2

Up to 50m of piping without additional gas charging makes installation flexible, easy and hassle-free.

A 50m pipe length is sufficient for most residential and small business buildings. When total piping length exceeds 50m, additional refrigerant charge is required.

**Chargeless**  
Max. total piping length: **50m**

**Charge**  
Max. total piping length: **180m**  
(Actual length: **150m**)

[ Sample piping lay-out ]

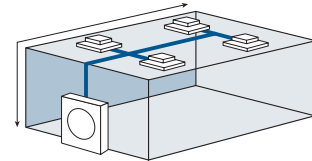

Compact design

LE1 LE2

Also, since Mini VRF LE Series is a single unit, it is possible to install the unit in more various places compared to the Single Split system.

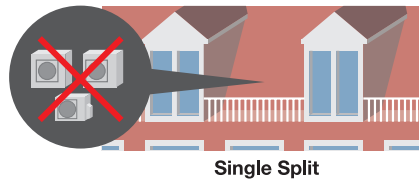

Single Split

Mini-FSV

Short height of 996mm

LE2

In addition to raising efficiency, we have made the outdoor unit more compact. It can now be installed in places that were previously too small.



Can be installed in the small space

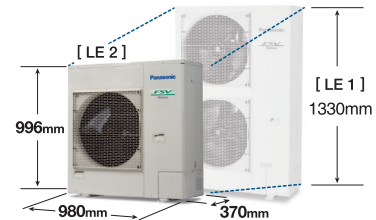

Up to 13 indoor units connectable

LE1 LE2

An expansion from Panasonic VRF line up, the mini FSV is compatible with the same indoor units and controls as the rest of the FSV range.

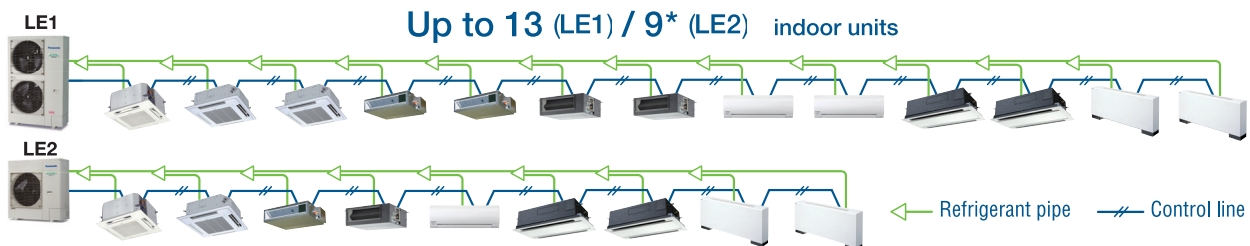

\* Use any of the 22 type indoor models. Depending on the size or type of indoor unit, tubing size shall be changed. Please refer manuals for details.

\* Diversity ration 50-130%

\* 6 HP only; 4 HP for 7 units, 5 HP for 8 units.

# 2-WAY Mini-FSV LE Series

## High efficiency

LE1 LE2

The operation efficiency has been improved using highly efficient R410A refrigerant, a DC Inverter compressor, DC motor and a heat exchanger design.

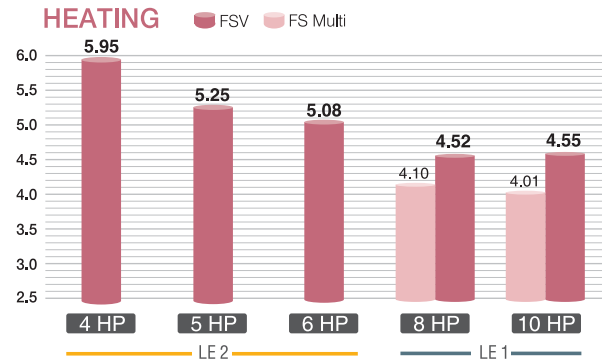
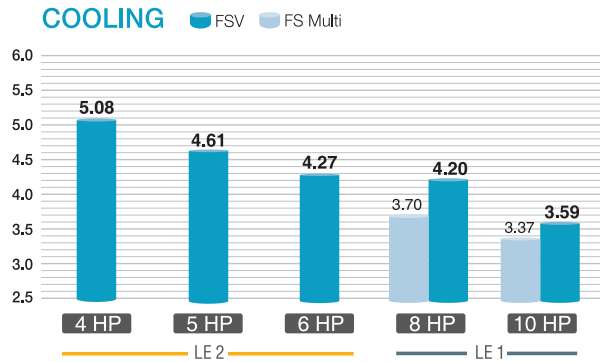

## Energy savings design

LE1 LE2

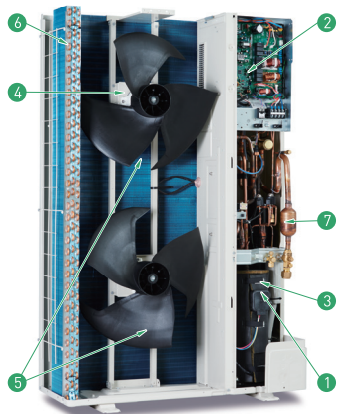

- 1 Panasonic Inverter Compressor** A large-capacity inverter compressor has been adopted. The inverter compressor is superior in performance with improved partial-load capacity.
- 2 Printed Circuit Board** The number of PCB is 2 pieces for making maintenance easier.
- 3 Accumulator** A large accumulator has been adopted to maintain compressor reliability because of the increased refrigerant quantity, which allows an extended max piping length.
- 4 DC Fan Motor** Checking load and outside temperature, the DC motor is controlled for optimum air volume.
- 5 Newly Designed Fan** The newly designed fan blades have been developed to inhibit air turbulence and to increase efficiency. As fan diameter has been increased its size, the air volume has been increased whilst maintaining a same sound level.
- 6 Heat Exchanger & Copper Tubes** The heat exchanger size and the copper tube sizes in the heat exchanger have been redesigned to increase efficiency.
- 7 Oil Separator** A centrifugal separator has been adopted to improve oil separation efficiency and reduce refrigerant pressure loss.

## Flexible demand response with the optional terminal block

LE1 LE2

### Demand Response

Featuring inverter control technology, all Panasonic Mini FSV systems are Demand Response Management (DRM) ready. With this control, power consumption at times of peak load can be set in three steps to deliver optimum performance. This helps to reduce annual power consumption with minimal loss in comfort.

\*Terminal block parts to be supplied separately. Please ask your dealer.

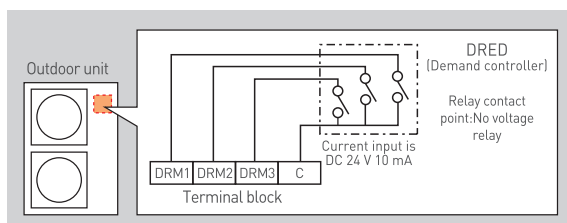

### Flexible Demand Response with the CZ-CAPDC2<sup>\*1</sup>

Setting is possible as 0% or in the range from 40 to 100% (in steps of 5%). At the time of shipping, setting has been done to the three steps of 0%, 70% and 100%.

\*1 An outdoor Seri-Para I/O unit (CZ-CAPDC2) is required for demand input signal.  
\* Demand timer setting for high spec remote controller is available.

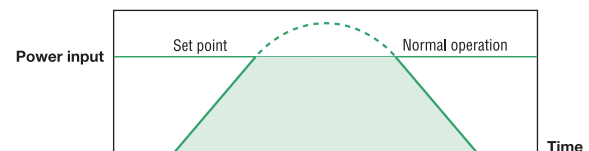

	Power input	
Level 1	100% (Preset)	Possible to change 40-100%
Level 2	70% (Preset)	
Level 3	0% (Always in stop condition)	



### Wide operating range

LE1 LE2

- Cooling operation is possible even when outdoor temperature is as low as -10°C DB.
- Cooling operation is possible even when outdoor temperature is as high as 46°C DB.
- Heating operation is possible even when outdoor temperature is as low as -20°C WB.

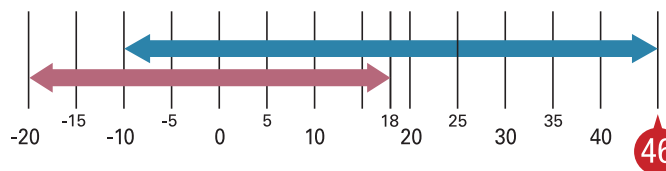

■ Cooling: -10°C DB ~ 46°C DB    ■ Heating: -20°C WB ~ 18°C WB  
 \* For further information please refer to the capacity tables in the Technical Data Book.

The remote controller temperature can be set from 18°C up to 30°C (Cooling), 16°C up to 30°C (Heating)\*1.

\*1 Depending on the type of remote controller.

### Blue fin condenser

LE1 LE2

The anti-corrosion Blue Fin treatment of the heat exchanger provides greater resistance against corrosion. All models are equipped with Blue Fin condenser.

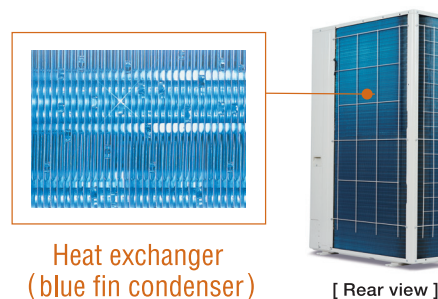

### High durability outdoor unit

LE1 LE2

Corrosion-resistance treated for high resistance to rust and salty air to assure long-lasting performance.

Note: Selecting this unit does not completely eliminate the possibility of rust developing. For details concerning unit installation and maintenance, please consult an authorised dealer.

\* Specific model with suffix "E" has this treatment.

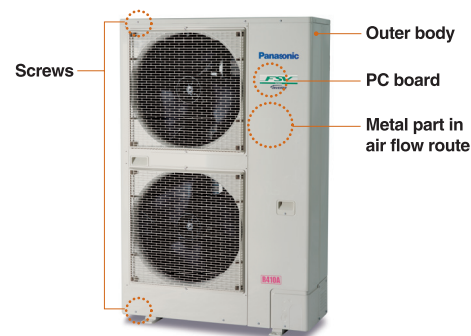

### Quiet operation mode

LE1 LE2

- Quiet operation mode reduces outdoor unit operating sound down to 7dB than rating.
- 3-step set point is available.
- External input signal is also available.

\* Timer setting of quiet operation mode is available in High-spec Remote Controller.



## 2-WAY Mini-FSV LE2 Series

HP	4			4			5			5			6			6					
Model name	U-4LE2H4			U-4LE2H7			U-5LE2H4			U-5LE2H7			U-6LE2H4			U-6LE2H7					
Power supply	220/230/240V/ 1-phase/50Hz 220/230V/1-phase/60Hz			380/400/415V/ 3-phase/50Hz 380/400V/3-phase/60Hz			220/230/240V/ 1-phase/50Hz 220/230V/1-phase/60Hz			380/400/415V/ 3-phase/50Hz 380/400V/3-phase/60Hz			220/230/240V/ 1-phase/50Hz 220/230V/1-phase/60Hz			380/400/415V/ 3-phase/50Hz 380/400V/3-phase/60Hz					
Voltage	220V	230V	240V	380V	400V	415V	220V	230V	240V	380V	400V	415V	220V	230V	240V	380V	400V	415V			
Capacity	Cooling	kW	12.1			12.1			14.0			14.0			15.5			15.5			
		BTU/h	41,300			41,300			47,800			47,800			52,900			52,900			
	Heating	kW	12.5			12.5			16.0			16.0			16.5			16.5			
		BTU/h	42,700			42,700			54,600			54,600			56,300			56,300			
EER/COP	Cooling	W/W	5.08			5.08			4.61			4.61			4.27			4.27			
	Heating	W/W	5.95			5.95			5.25			5.25			5.08			5.08			
Dimensions	H x W x D	mm			996 x 980 x 370			996 x 980 x 370			996 x 980 x 370			996 x 980 x 370			996 x 980 x 370				
Net weight	kg	106			106			106			106			106			106				
Electrical ratings	Cooling	Running current	A	11.90	11.40	10.90	3.89	3.69	3.56	15.20	14.50	13.90	4.91	4.67	4.50	18.10	17.30	16.60	5.87	5.57	5.37
		Power input	kW	2.38	2.38	2.38	2.38	2.38	2.38	3.04	3.04	3.04	3.04	3.04	3.04	3.63	3.63	3.63	3.63	3.63	3.63
	Heating	Running current	A	10.60	10.10	9.70	3.47	3.29	3.18	15.20	14.60	14.0	4.93	4.68	4.51	16.20	15.50	14.90	5.25	4.99	4.81
		Power input	kW	2.10	2.10	2.10	2.10	2.10	2.10	3.05	3.05	3.05	3.05	3.05	3.05	3.25	3.25	3.25	3.25	3.25	3.25
Starting current	A	1			1			1			1			1			1				
Air flow rate	m <sup>3</sup> / min	69			69			72			72			74			74				
	L/s	1,150			1,150			1,200			1,200			1,233			1,233				
Refrigerant amount at shipment	kg	R410A 6.70			R410A 6.70			R410A 6.70			R410A 6.70			R410A 6.70			R410A 6.70				
Piping connection	Gas pipe	mm (inches)	Ø15.88 (Ø5/8)			Ø15.88 (Ø5/8)			Ø15.88 (Ø5/8)			Ø15.88 (Ø5/8)			Ø15.88 (Ø5/8)			Ø15.88 (Ø5/8)			
	Liquid pipe	mm (inches)	Ø9.52 (Ø3/8)			Ø9.52 (Ø3/8)			Ø9.52 (Ø3/8)			Ø9.52 (Ø3/8)			Ø9.52 (Ø3/8)			Ø9.52 (Ø3/8)			
Ambient temperature operating range		Cooling: -10°CDB~+46°CDB, Heating: -20°CWB~+18°CWB			Cooling: -10°CDB~+46°CDB, Heating: -20°CWB~+18°CWB			Cooling: -10°CDB~+46°CDB, Heating: -20°CWB~+18°CWB			Cooling: -10°CDB~+46°CDB, Heating: -20°CWB~+18°CWB			Cooling: -10°CDB~+46°CDB, Heating: -20°CWB~+18°CWB			Cooling: -10°CDB~+46°CDB, Heating: -20°CWB~+18°CWB				
Sound pressure level (Cooling)	Normal mode	dB(A)	52.0			52.0			53.0			53.0			54.0			54.0			
	Silent mode (3)	dB(A)	45.0			45.0			46.0			46.0			47.0			47.0			
Sound power level (Cooling)	Normal mode	dB	69.0			69.0			71.0			71.0			73.0			73.0			

Global remarks	Rated conditions:	Cooling	Heating
	Indoor air temperature	27°C DB / 19°C WB	20°C DB
	Outdoor air temperature	35°C DB	7°C DB / 6°C WB

\* As a foot print.  
\*\* High durable model (with suffix "E") has same specifications.

### Dimensions

U-4LE2H4 / U-4LE2H7  
U-5LE2H4 / U-5LE2H7  
U-6LE2H4 / U-6LE2H7

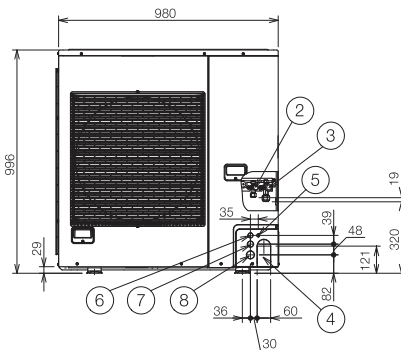
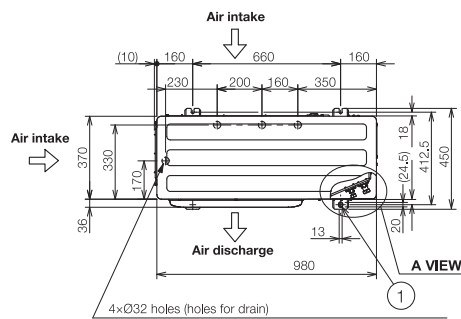

- |   |   |
|---|---|
| ① | Mounting hole (4-R6.5), anchor bolt : M10                   |
| ② | Refrigerant tubing (liquid tube), flared connection (Ø9.52) |
| ③ | Refrigerant tubing (gas tube), flared connection (Ø15.88)   |
| ④ | Refrigerant tubing port                                     |
| ⑤ | Electrical wiring port (Ø13)                                |
| ⑥ | Electrical wiring port (Ø22)                                |
| ⑦ | Electrical wiring port (Ø27)                                |
| ⑧ | Electrical wiring port (Ø35)                                |

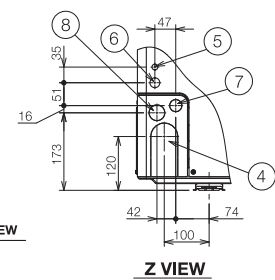
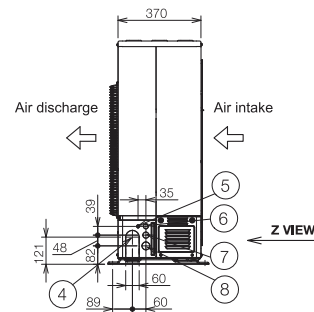
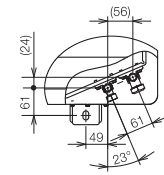

Unit: mm

## 2-WAY Mini-FSV LE1 Series

HP	8			10					
<b>Model name</b>	<b>U-8LE1H7</b>			<b>U-10LE1H7</b>					
Power supply	380/400/415V/3-phase/50Hz 380/400V/3-phase/60Hz			380/400/415V/3-phase/50Hz 380/400V/3-phase/60Hz					
Voltage	380V	400V	415V	380V	400V	415V			
Capacity	Cooling	kW	22.4			28.0			
		BTU/h	76,500			95,600			
	Heating	kW	25.0			28.0			
		BTU/h	85,300			95,600			
EER/COP	Cooling	W/W	4.20			3.59			
	Heating	W/W	4.52			4.55			
Dimensions (H/W/D)	mm			1,500 x 980 x 370			1,500 x 980 x 370		
Net weight	kg			132			133		
Electrical ratings	Cooling	Running current	A	8.70	8.25	7.95	12.7	12.1	11.7
		Power input	kW	5.33	5.33	5.33	7.8	7.80	7.80
	Heating	Running current	A	9.05	8.60	8.25	10.0	9.55	9.20
		Power input	kW	5.53	5.53	5.53	6.15	6.15	6.15
Starting current	A			1			1		
Air flow rate	m <sup>3</sup> / min			150			160		
	L/s			2,500			2,666		
Refrigerant amount at shipment	kg			R410A 6.30			R410A 6.60		
Piping connection	Gas pipe	mm (inches)	Ø19.05 (Ø3/4)			Ø22.22 (Ø7/8)			
	Liquid pipe	mm (inches)	Ø9.52 (Ø3/8)			Ø9.52 (Ø3/8)			
Ambient temperature operating range	Cooling: -10°CDB~+46°CDB, Heating: -20°CWB~+18°CWB			Cooling: -10°CDB~+46°CDB, Heating: -20°CWB~+18°CWB					
Sound pressure level (Cooling)	Normal mode	dB(A)	59.0			62.0			
	Silent mode	dB(A)	52.0			55.0			
Sound power level (Cooling)	Normal mode	dB(A)	80.0			83.0			

Global remarks	Rated conditions:	Cooling	Heating
	Indoor air temperature	27°C DB / 19°C WB	20°C DB
	Outdoor air temperature	35°C DB	7°C DB / 6°C WB

\* As a foot print.

\*\* High durable model (with suffix "E") has same specifications.

### Dimensions

#### U-8LE1H7 / U-10LE1H7

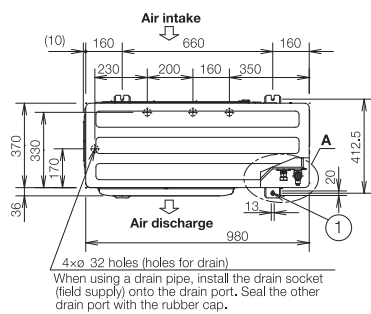

- ① Mounting hole (4-R6.5), anchor bolt : M10
- ② Refrigerant tubing (liquid tube), flared connection (ø9.52) for 8-10 HP finally.
- ③ Refrigerant tubing (gas tube), flared connection (ø19.05)
- ④ Refrigerant tubing port
- ⑤ Electrical wiring port (ø13)
- ⑥ Electrical wiring port (ø22)
- ⑦ Electrical wiring port (ø27)
- ⑧ Electrical wiring port (ø35)

#### For U-10LE1H7

The tubing of the gas main has a diameter of ø22.22, but the connection to the service valve of the outdoor unit has a diameter of ø19.05, so a flare has to be used. Consequently, be sure to use the enclosed joint tube B and joint tube A in making connections (brazing).

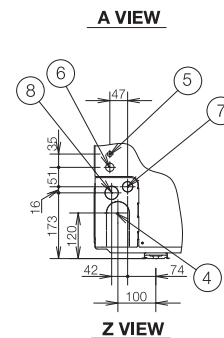
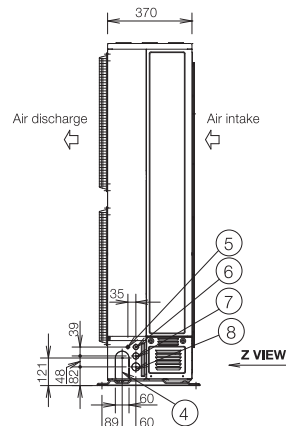
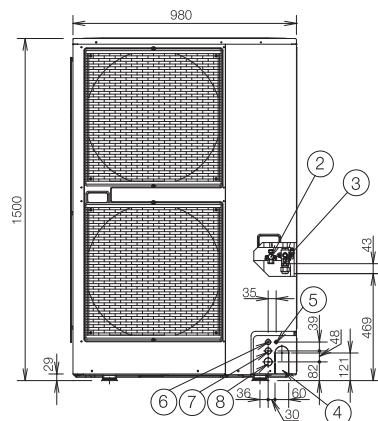
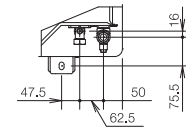

Unit: mm



# 2-WAY Mini-FSV LE2 Series

## Distribution Joint Kits

### CZ-P160BK2

Use: For indoor unit (Capacity after distribution joint is 22.4 kW or less.)\*

\* In case the total capacity of indoor units connected after distribution exceeds the total capacity of the outdoor units, select the distribution piping size for the total capacity of the outdoor units.

#### GAS PIPING

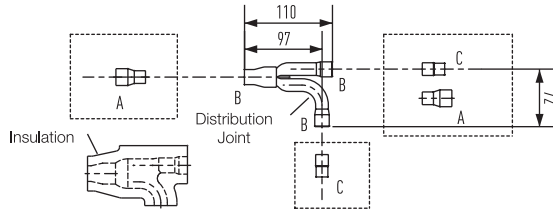

#### LIQUID PIPING

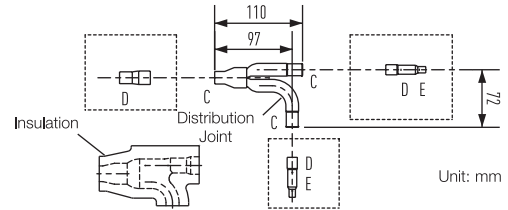

Unit: mm

Size of connection point on each part (Shown are inside diameters of piping)					
Size	Part A	Part B	Part C	Part D	Part E
Dimension (mm)	Ø19.05	Ø15.88	Ø12.70	Ø9.52	Ø6.35
Dimension (inches)	Ø3/4	Ø5/8	Ø1/2	Ø3/8	Ø1/4

## Wiring System Diagrams (LE2/LE1)

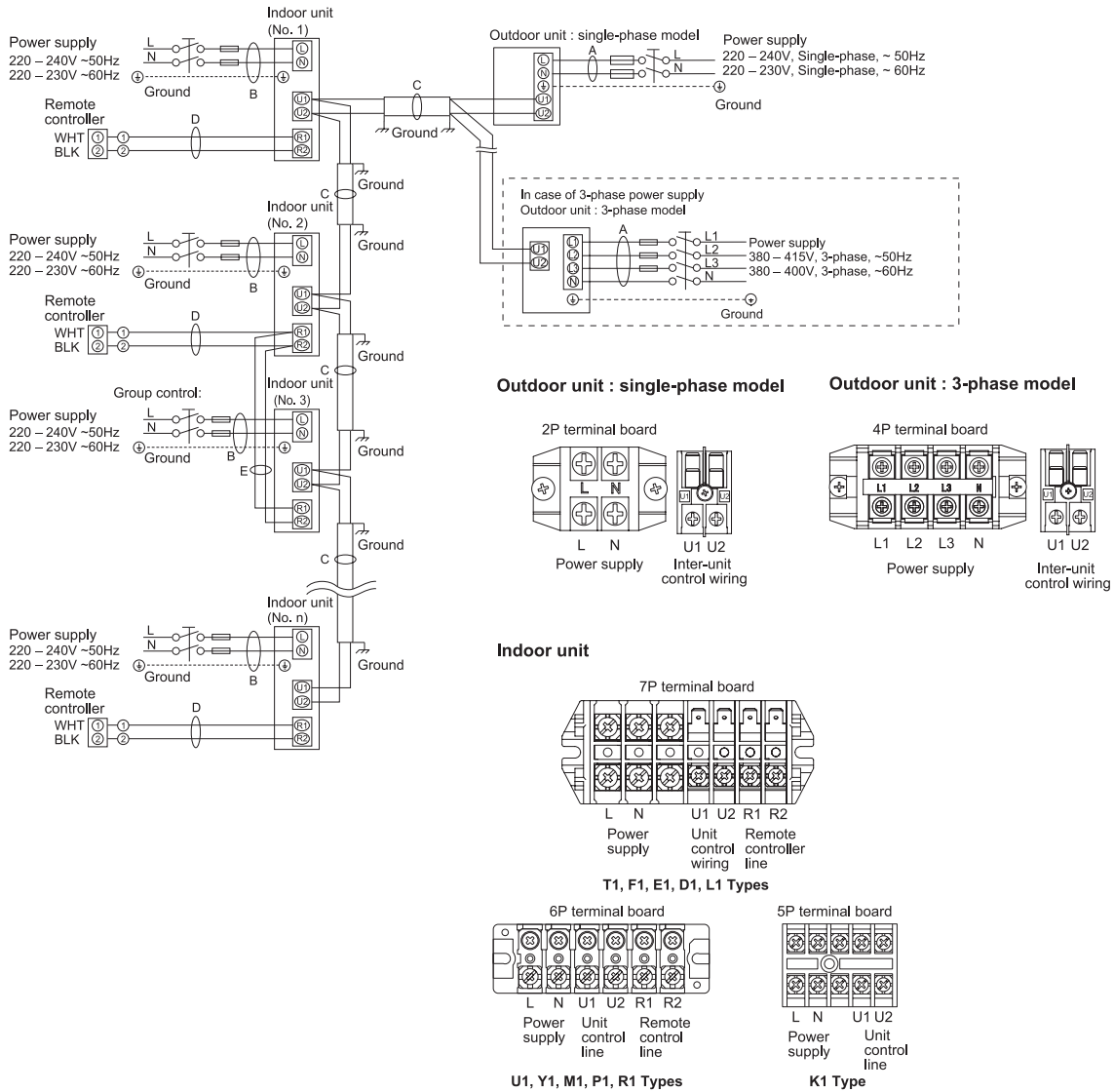
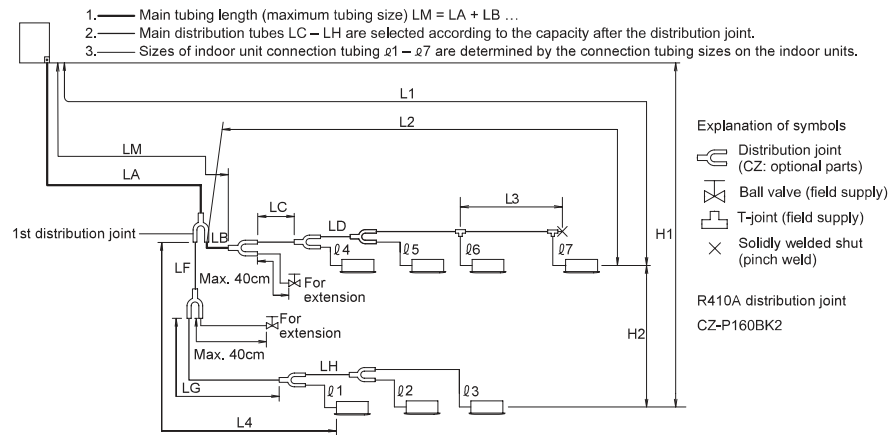

Fig. 2-1

### Piping Design

Select the installation location so that the length and size of refrigerant piping are within the allowable range shown in the figure below.



### Ranges that Apply to Refrigerant Piping Lengths and to Differences in Installation Heights

Items	Mark	Contents	Length (m)	
Allowable piping length	L1	Max. piping length	Actual length	≤150
			Equivalent length	≤175
	ΔL (L2 - L4)	Difference between max. length and min. length from the 1st distribution joint	≤50	
	LM	Max. length of main piping (at maximum size) *Even after 1st distribution joint, LM is allowed if at maximum piping length.	—	
	φ1, φ2- φ7	Max. length of each distribution pipe	≤50	
Allowable elevation difference	H1	When outdoor unit is installed higher than indoor unit	≤50	
		When outdoor unit is installed lower than indoor unit	≤40	
	H2	Max. difference between indoor units	≤15	
Allowable length of joint piping	L3	T-joint piping (field-supply); Max. piping length between the first T-joint and solidly welded-shut end point	≤2	

L = Length, H = Height

### Piping Size

#### Main Piping Size (LA)

	12.1 kW	14.0 kW	15.5 kW
Gas tubing mm (inches)	φ15.88 (ø5/8)		
	Flare connection		
Liquid tubing mm (inches)	φ9.52 (ø3/8)		
	Flare connection		

Note :The refrigerant piping should be used with R410A refrigerant.

#### Main Piping Size After Distribution (LB, LC...)

Total capacity after distribution	Below kW	7.1 (2.5HP)	—
	Over kW	—	7.1 (2.5HP)
Piping size	Gas piping	(mm)	φ12.7
		(inches)	ø1/2
	Liquid piping	(mm)	φ9.52
		(inches)	ø3/8

Note: In case the total capacity of indoor units connected after distribution exceeds the capacity of the outdoor unit, select the main piping size for the capacity of the outdoor unit.

#### Indoor Unit Piping Connection (φ1, φ2...φn-1)

Indoor unite type	22	28	36	45	56	60	71/73	90	106	140	160	
Gas piping mm (inches)	φ12.7 (ø1/2)					φ15.88 (ø5/8)						
Liquid piping mm (inches)	φ6.35 (ø1/4)					φ9.52 (ø3/8)						

### System Limitations

Outdoor units	12.1 kW	14.0 kW	15.5 kW
Number of max. connectable indoor units	7	8	9
Max. allowable indoor/outdoor capacity ratio	50 - 130%		

kW = kilowatts

# 2-WAY Mini-FSV LE1 Series

## Distribution Joint Kits

### CZ-P160BK2

Use: For indoor unit (Capacity after distribution joint is 22.4 kW or less.)\*

\* In case the total capacity of indoor units connected after distribution exceeds the total capacity of the outdoor units, select the distribution piping size for the total capacity of the outdoor units.

#### GAS PIPING

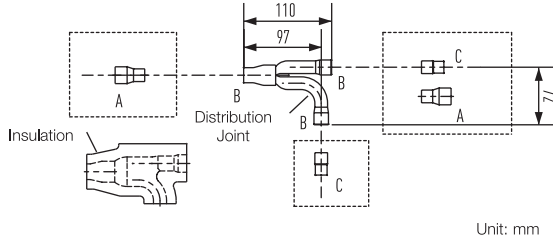

#### LIQUID PIPING

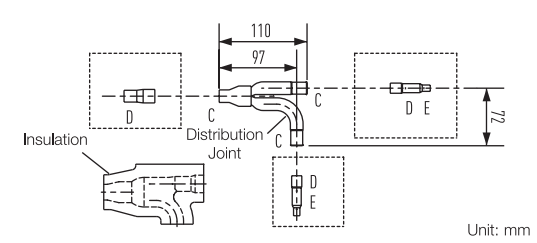

Size of connection point on each part (Shown are inside diameters of tubing)					
Size	Part A	Part B	Part C	Part D	Part E
Dimension (mm)	Ø19.05	Ø15.88	Ø12.70	Ø9.52	Ø6.35
Dimension (inches)	Ø3/4	Ø5/8	Ø1/2	Ø3/8	Ø1/4

### CZ-P680BK2

Use: For indoor unit (Capacity after distribution joint is greater than 22.4 kW and no more than 68.0 kW.)\*

\* In case the total capacity of indoor units connected after distribution exceeds the total capacity of the outdoor units, select the distribution piping size for the total capacity of the outdoor units.

#### GAS PIPING

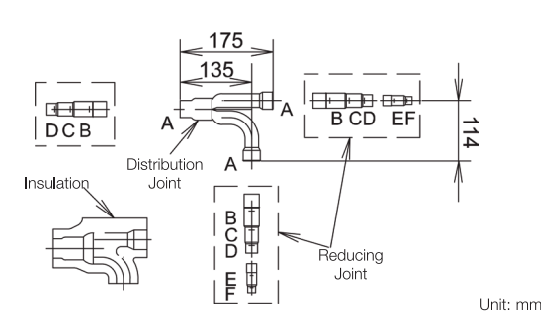

#### LIQUID PIPING

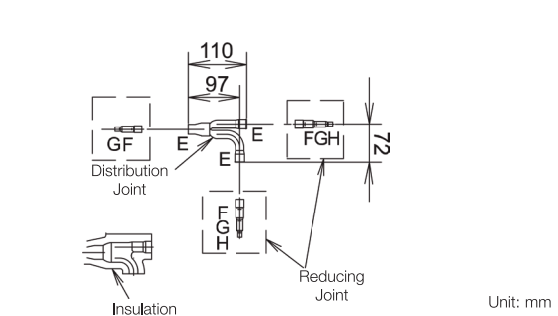

Size of connection point on each part (Shown are inside diameters of piping)								
Size	Part A	Part B	Part C	Part D	Part E	Part F	Part G	Part H
Dimension (mm)	Ø28.58	Ø25.4	Ø22.22	Ø19.05	Ø15.88	Ø12.7	Ø9.52	Ø6.35
Dimension (inches)	Ø1-1/8	Ø1	Ø7/8	Ø3/4	Ø5/8	Ø1/2	Ø3/8	Ø1/4



### Piping design

Select the installation location so that the length and size of refrigerant piping are within the allowable range shown in the figure below.

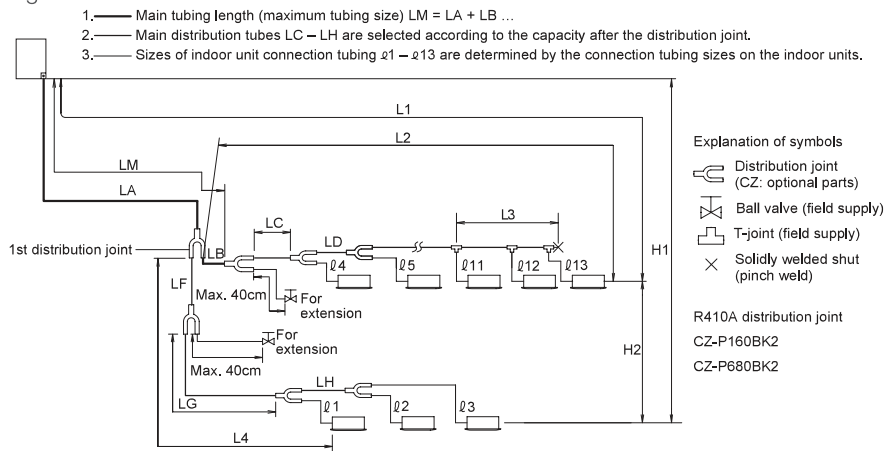

### Ranges that Apply to Refrigerant Piping Lengths and to Differences in Installation Heights

Items	Mark	Contents	Length (m)
Allowable piping length	L1	Max. piping length	Actual length $\leq 150$ Equivalent length $\leq 175$
		$\Delta L (L2 - L4)$	Difference between max. length and min. length from the 1st distribution joint $\leq 50$
	LM	Max. length of main piping (at maximum size) *Even after 1st distribution joint, LM is allowed if at maximum piping length.	—
	$\phi 1, \phi 2 - \phi 13$	Max. length of each distribution pipe	$\leq 50$
	$L1 + \phi 1 + \phi 2 - \phi 12 + LF + LG + LH$	Total max. piping length including length of each distribution pipe (only liquid piping)	$\leq 300$
Allowable elevation difference	H1	When outdoor unit is installed higher than indoor unit	$\leq 50$
	H2	When outdoor unit is installed lower than indoor unit	$\leq 40$
Allowable length of joint piping	L3	Max. difference between indoor units	$\leq 15$
		T-joint piping (field-supply); Max. piping length between the first T-joint and solidly welded-shut end point	$\leq 2$

L = Length, H = Height

### Piping Size

#### Main Piping Size (LA)

	22.4 kW	28.0 kW
Outdoor unit horsepower	8 HP	10 HP
Gas piping mm (inches)	$\phi 19.05 (\phi 3/4)$	$\phi 22.22 (\phi 7/8)$
	Flare connection	Brazing connection
Liquid piping mm (inches)	$\phi 9.52 (\phi 3/8)$	
	Flare connection	

Note :If future extension is planned, select the piping diameter based on the total horsepower after extension. The refrigerant piping should be used with R410A refrigerant.

#### Main Piping Size After Distribution (LB, LC...)

Total capacity after distribution	Below kW	7.1 (2.5HP)	16.0 (6 HP)	22.5 (8.1 HP)	—	
	Over kW	—	7.1 (2.5 HP)	16.0 (6 HP)	22.5 (8.1 HP)	
Piping size	Gas tubing	(mm)	$\phi 12.7$	$\phi 15.88$	$\phi 19.05$	$\phi 22.22$
		(inches)	$\phi 1/2$	$\phi 5/8$	$\phi 3/4$	$\phi 7/8$
	Liquid tubing	(mm)	$\phi 9.52$	$\phi 9.52$	$\phi 9.52$	$\phi 9.52$
		(inches)	$\phi 3/8$	$\phi 3/8$	$\phi 3/8$	$\phi 3/8$

kW = kilowatts

Note :In case the total capacity of connected indoor units exceeds the total capacity of the outdoor units, select the main piping size for the total capacity of the outdoor units.

#### Indoor Unit Piping Connection ( $\phi 1, \phi 2 \dots \phi n-1$ )

Indoor unit type	22	28	36	45	56	60	71/73	90	106	140	160	180	224	280
Gas tubing mm (inches)	$\phi 12.7 (\phi 1/2)$					$\phi 15.88 (\phi 5/8)$			$\phi 19.05 (\phi 3/4)$		$\phi 22.22 (\phi 7/8)$			
Liquid tubing mm (inches)	$\phi 6.35 (\phi 1/4)$					$\phi 9.52 (\phi 3/8)$								

### System Limitations

Outdoor units	22.4 kW (8 HP)	28.0 kW (10 HP)
Number of max. connectable indoor units	13	13
Max. allowable indoor/outdoor capacity ratio	50 – 130%	

# Indoor Units

Wide choice of models depending on the indoor requirements

## ECONAVI sensor



Providing outstanding energy-saving performance, Panasonic's inverter VRF System can be connected to ECONAVI to detect when energy is being wasted. ECONAVI senses the presence or absence of people and the level of activity in each area of an office. When unnecessary heating or cooling is detected, indoor units are individually controlled to match office conditions for energy-saving operation.

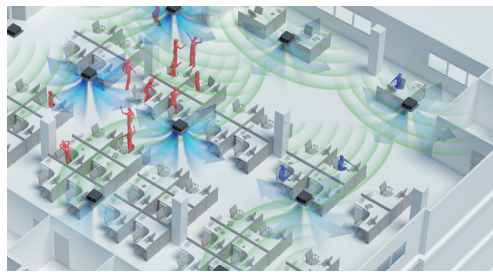

ECONAVI Sensor  
CZ-CENSC1



### Detection of the level of activity enables optimum power saving

Activity or absence of people at their desks and the level of activity in the office are detected in real time. Cooling or heating is automatically adjusted for optimum operation required to lower power consumption.



### Sensor is remotely located to maximize the energy saving effect

Pillars, walls, cabinets and other fittings obstruct the sensors, reducing the area of detection and lowering the energy-saving effect. Taking into consideration blind spots, Panasonic enables the optimum layout for sensors in any office.

## High-spec Wired Remote Controller

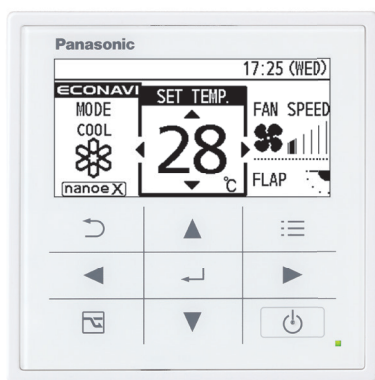

CZ-RTC5B

### Large 3.5" full-dot LCD with white LED backlight

Characters and icons are clearly displayed for improved visibility. The display is also large enough to provide a wide range of information for easy confirmation of operation conditions.



### Stylish, easy-to-use touch key design

The elegant, flat design features large touch keys in a simple layout enabling easy, intuitive operation.



## Key Indoor Units Equipped DC motors



### All Ducted Series / F2,M1,Z1,E2,E1,H1, type

#### Discharge air temperature control

Smart sensors control discharge air temperature for precise room temperature control. Possible to reduce cold drafts during heating operation.

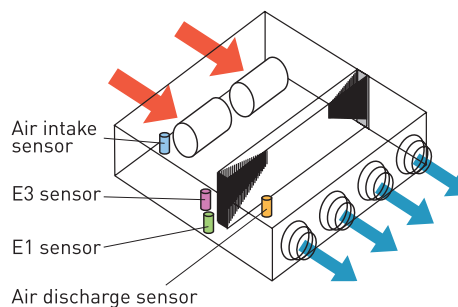

### Wall Mounted / K2 (22~36), K2 (45~106) type



Compact design with flat surface enables seamless match with any type of room interior

#### Noise reducing external valve kit

To reduce noise level of expansion valve. (Optional accessory)

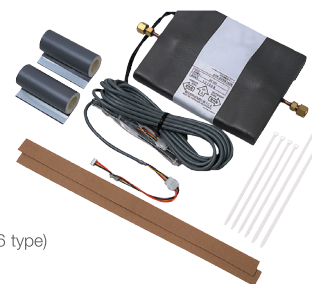

CZ-P56SVK2 (for 22 - 56 type)  
CZ-P160SVK2 (for 73 - 106 type)

### Remote Temperature Sensor









































































CZ-CSRC3

- This is a remote sensor which can be used with indoor units. Use it to detect the room temperature when no remote controller sensor or body sensor is used (connection to a system without a remote controller is possible).
- For joint use with a remote control switch, use the remote control switch as main remote controller.



# FSV Indoor Units Range

Wide choice of models depending on the indoor requirements

Class	22	28	36	45	56	60	73	
Capacity	Cooling/Heating		Cooling/Heating		Cooling/Heating		Cooling/Heating	
Type	Cooling/Heating		Cooling/Heating		Cooling/Heating		Cooling/Heating	
kW	2.2/2.5	2.8/3.2	3.6/4.2	4.5/5.0	5.6/6.3	6.0/7.1	7.3/8.0	
BTU/h	7,500/8,500	9,600/11,000	12,000/14,000	15,000/17,000	19,000/21,000	20,400/24,200	25,000/27,000	
<b>F2 type  Mid Static Ducted</b>	 S-22MF2E5A	 S-28MF2E5A	 S-36MF2E5A	 S-45MF2E5A	 S-56MF2E5A	 S-60MF2E5A	 S-73MF2E5A	
<b>M1 type  Slim Low Static Ducted</b>	 S-22MM1E5A	 S-28MM1E5A	 S-36MM1E5A	 S-45MM1E5A	 S-56MM1E5A			
<b>Z1 type  Slim Low Static Ducted Twenty Series</b>	 S-22MZ1H4A	 S-28MZ1H4A	 S-36MZ1H4A	 S-45MZ1H4A	 S-56MZ1H4A	 S-60MZ1H4A	 S-73MZ1H4A	
<b>E2 type High Static Ducted / Energy Saving High-Fresh Air Ducted</b>								
<b>H1 type High Fresh Air Ducted</b>								
<b>K2 type  Wall Mounted</b>	 S-22MK2E5A	 S-28MK2E5A	 S-36MK2E5A	 S-45MK2E5A	 S-56MK2E5A		 S-73MK2E5A	
<b>U2 type  4-Way Cassette</b> Panel No. CZ-KPU3H Panel No. CZ-KPU3A	 S-22MU2E5A	 S-28MU2E5A	 S-36MU2E5A	 S-45MU2E5A	 S-56MU2E5A	 S-60MU2E5A	 S-73MU2E5A	
<b>Y2 type  4-Way Mini Cassette</b> Panel No. CZ-KPY3AW	 S-22MY2E5A	 S-28MY2E5A	 S-36MY2E5A	 S-45MY2E5A	 S-56MY2E5A			
<b>L1 type 2-Way Cassette</b> Panel No. CZ-02KPL2 Panel No. CZ-03KPL2 (Only for S-73ML1E5)	 S-22ML1E5	 S-28ML1E5	 S-36ML1E5	 S-45ML1E5	 S-56ML1E5		 S-73ML1E5	
<b>D1 type 1-Way Cassette</b> Panel No. CZ-KPD2		 S-28MD1E5	 S-36MD1E5	 S-45MD1E5	 S-56MD1E5		 S-73MD1E5	
<b>T2 type  Ceiling Mounted</b>			 S-36MT2E5A	 S-45MT2E5A	 S-56MT2E5A		 S-73MT2E5A	
<b>P1 type Floor Standing</b>	 S-22MP1E5	 S-28MP1E5	 S-36MP1E5	 S-45MP1E5	 S-56MP1E5		 S-71MP1E5	
<b>R1 type Concealed Floor Standing</b>	 S-22MR1E5	 S-28MR1E5	 S-36MR1E5	 S-45MR1E5	 S-56MR1E5		 S-71MR1E5	















































































































\* Only for High Static Ducted  
\*\* Only for CZ-KPU3A



Self-diagnosing function



Automatic fan operation

90	106	140	160	180	224	280	Functions
Cooling/Heating	Cooling/Heating	Cooling/Heating	Cooling/Heating	Cooling/Heating	Cooling/Heating	Cooling/Heating	
9.0/10.0 30,000/34,000	10.6/11.4 36,000/39,000	14.0/16.0 47,800/54,600	16.0/18.0 54,600/61,500	18.0/20.0 61,400/68,200	22.4/25.0 76,400/85,300	28.0/31.5 95,500/107,500	
 S-90MF2E5A	 S-106MF2E5A	 S-140MF2E5A	 S-160MF2E5A				 self-diagnosing  Auto fan  DRY  Mild dry  Auto restart  Drain pump  DC motor
							 self-diagnosing  Auto fan  DRY  Mild dry  Auto restart  Drain pump  DC motor
							 self-diagnosing  Auto fan  DRY  Mild dry  Auto restart  DC motor
				 S-180ME2E5 *	 S-224ME2E5 High Fresh Air	 S-280ME2E5 High Fresh Air	 self-diagnosing  Auto fan  DRY  Mild dry  Auto restart  DC motor
		 S-140MH1H5 High Fresh Air			 S-224MH1H5 High Fresh Air	 S-280MH1H5 High Fresh Air	 self-diagnosing  Auto fan  Auto restart
	 S-106MK2E5A						 self-diagnosing  Auto fan  DRY  Mild dry  Auto restart  Auto fan  Auto flap  DC motor
 S-90MU2E5A	 S-106MU2E5A	 S-140MU2E5A	 S-160MU2E5A				 self-diagnosing  Auto fan  DRY  Mild dry  Auto restart  Auto fan  Auto flap  Air swing  DRP  DC motor
							 self-diagnosing  Auto fan  DRY  Mild dry  Auto restart  Auto fan  Auto flap  Air swing  DRP  DC motor
							 self-diagnosing  Auto fan  DRY  Mild dry  Auto restart  Auto fan  Auto flap  Air swing  DRP  DC motor
							 self-diagnosing  Auto fan  DRY  Mild dry  Auto restart  Auto fan  Auto flap  Air swing  DRP  DC motor
	 S-106MT2E5A	 S-140MT2E5A					 self-diagnosing  Auto fan  DRY  Mild dry  Auto restart  Auto fan  DC motor
							 self-diagnosing  Auto fan  DRY  Mild dry  Auto restart
							 self-diagnosing  Auto fan  DRY  Mild dry  Auto restart

 Mild dry
  Intelligent auto flap control
  Automatic restart function for power failure
  Air swing
  Built-in drain pump
  DC motor

# F2 TYPE Mid Static Ducted



The new F2 type is designed specifically for applications requiring fixed square ducting. An anti-mould filter is equipped as standard.



Self-diagnosing Function



Automatic Fan Operation



Mild dry



Automatic Restart Function



Built-in Drain Pump

## Technical focus

- Variable external static pressure control
- Industry-leading low sound levels from 25 dB(A)
- Built-in drain pump provides 702 mm lift
- Easy to install and maintain
- Air off sensor avoids cold air drafts during heating operation
- Configurable air temperature control
- Anti-mould washable filters included

## Variable external static pressure control

Optimal airflow set-up is possible depending on ducting design and conditions.

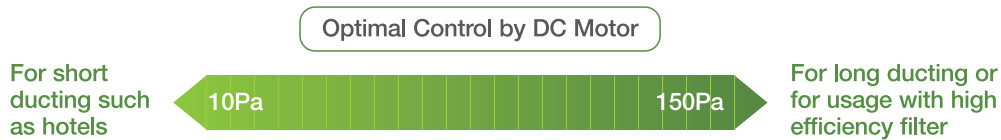

\* Please refer to technical databook for detail.

## System example

An inspection port (450 mm x 450 mm or larger) is required at the lower side of the indoor unit body.

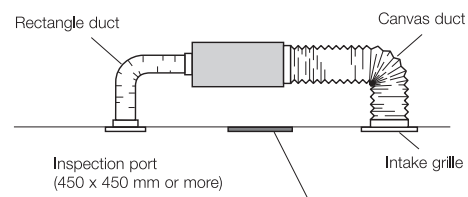

## More powerful drain pump

Using a high-lift drain pump, drain piping can be elevated up to 702 mm from the base of the unit.

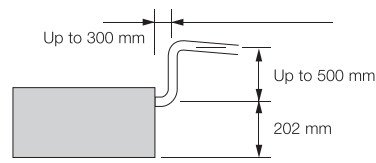





S-60MF2E5A / S-73MF2E5A / S-90MF2E5A



S-106MF2E5A / S-140MF2E5A / S-160MF2E5A



S-22MF2E5A / S-28MF2E5A / S-36MF2E5A / S-45MF2E5A / S-56MF2E5A

**ECONAVI**  
ECONAVI ready



CZ-CENSC1



CZ-RTC5B



CZ-RWS3



CZ-RWRC3

**Built-in Drain pump (DC motor pump)**

**Standardised height of 290 mm for all models**

Height standardisation enables easy and uniform installation for models with different capacities.

**External electrical equipment box makes maintenance easy**

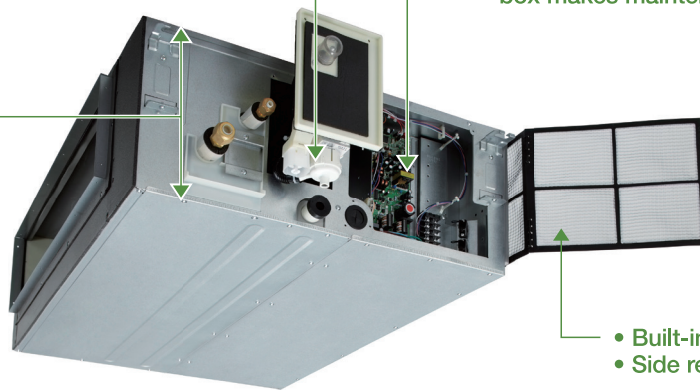

- Built-in filter
- Side removable filter

**Discharge air temperature control**

- Possible to control discharge air temperature for accurate room temperature control.
- Possible to reduce cold drafts during heating operation.

Before spec-in, please consult with an authorised Panasonic dealer.

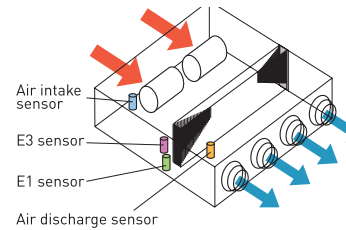

**V-shaped heat exchanger**

To improve heat exchange efficiency, an original V-shaped heat exchanger was developed incorporating a conventional high-efficiency slit fan and high-efficiency grooved heat transfer tubes. This increases the heat exchange surface area by about 80%.

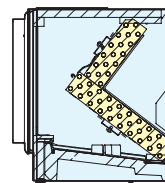

Increases surface area by about 30 to 80%



# F2<sub>TYPE</sub> Mid Static Ducted

Model Name			S-22MF2E5A	S-28MF2E5A	S-36MF2E5A	S-45MF2E5A	S-56MF2E5A
Power source			220/230/240V, 1 phase - 50/60Hz				
Cooling capacity	kW		2.2	2.8	3.6	4.5	5.6
	BTU/h		7,500	9,600	12,300	15,400	19,100
Heating capacity	kW		2.5	3.2	4.2	5.0	6.3
	BTU/h		8,500	10,900	14,300	17,100	21,500
Power input	Cooling	kW	0.070/0.070/0.070	0.070/0.070/0.070	0.070/0.070/0.070	0.070/0.070/0.070	0.100/0.100/0.100
	Heating	kW	0.070/0.070/0.070	0.070/0.070/0.070	0.070/0.070/0.070	0.070/0.070/0.070	0.100/0.100/0.100
Running amperes	Cooling	A	0.60/0.57/0.56	0.60/0.57/0.56	0.60/0.57/0.56	0.60/0.57/0.56	0.77/0.74/0.71
	Heating	A	0.60/0.57/0.56	0.60/0.57/0.56	0.60/0.57/0.56	0.60/0.57/0.56	0.77/0.74/0.71
Fan motor	Type		Sirocco fan	Sirocco fan	Sirocco fan	Sirocco fan	Sirocco fan
	Air flow rate (H/M/L)	m <sup>3</sup> /h	840/780/540	840/780/540	840/780/540	840/780/600	960/900/720
		L/s	233/217/150	233/217/150	233/217/150	233/217/167	267/250/200
	Output	kW	0.119	0.119	0.119	0.119	0.119
	External static pressure	Pa	70(10-150)	70(10-150)	70(10-150)	70(10-150)	70(10-150)
Sound power level (H/M/L)	dB	55/51/44	55/51/44	55/51/44	56/54/47	56/54/47	
Sound pressure sound (H/M/L)	dB(A)	33/29/22	33/29/22	33/29/22	34/32/25	34/32/25	
Dimensions	H x W x D	mm	290x800x700	290x800x700	290x800x700	290x800x700	290x800x700
Pipe connections	Liquid	mm (inches)	Ø6.35 (Ø1/4)	Ø6.35 (Ø1/4)	Ø6.35 (Ø1/4)	Ø6.35 (Ø1/4)	Ø6.35 (Ø1/4)
	Gas	mm (inches)	Ø12.7 (Ø1/2)	Ø12.7 (Ø1/2)	Ø12.7 (Ø1/2)	Ø12.7 (Ø1/2)	Ø12.7 (Ø1/2)
	Drain piping		VP-25	VP-25	VP-25	VP-25	VP-25
Net weight	kg		29	29	29	29	29

GLOBAL REMARKS	Rated conditions:	Cooling	Heating
	Indoor air temperature	27°C DB / 19°C WB	20°C DB
	Outdoor air temperature	35°C DB / 24°C WB	7°C DB / 6°C WB

Specifications are subject to change without notice.

## F2 TYPE MID STATIC DUCTED Dimensions

### SIZE 22-56

- 1 Refrigerant piping joint (liquid tube) Ø6.35 Flare
- 2 Refrigerant piping joint (gas tube) Ø12.7 Flare
- 3 Upper drain port VP25 (O.D. Ø32 mm)
- 4 200 flexible hose supplied
- 5 Suspension lug (4-12 x 30 mm)
- 6 Power supply outlet
- 7 Fresh air intake port (Ø150 mm)
- 8 Flange for flexible air outlet duct
- 9 Electrical component box

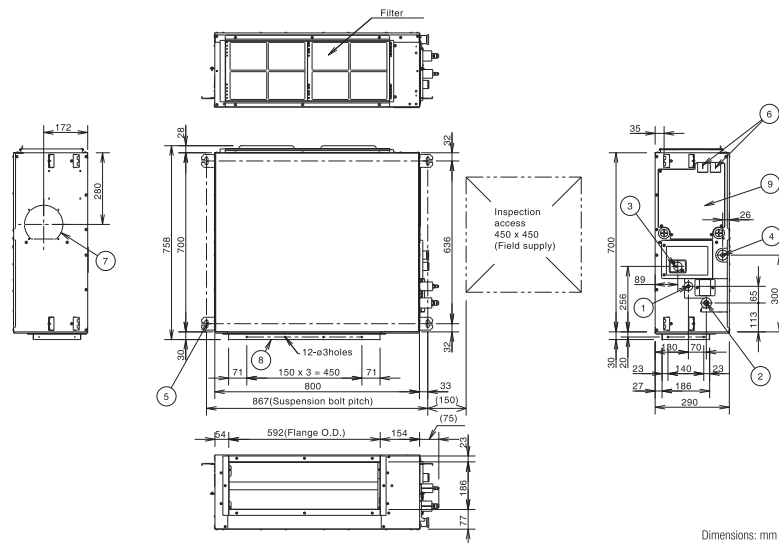

Dimensions: mm

S-60MF2E5A	S-73MF2E5A	S-90MF2E5A	S-106MF2E5A	S-140MF2E5A	S-160MF2E5A
220/230/240V, 1 phase - 50/60Hz					
6.0	7.3	9.0	10.6	14.0	16.0
20,500	24,900	30,700	36,200	47,800	54,600
7.1	8.0	10.0	11.4	16.0	18.0
24,200	27,300	34,100	38,900	54,600	61,400
0.120/0.120/0.120	0.120/0.120/0.120	0.135/0.135/0.135	0.195/0.195/0.195	0.215/0.215/0.215	0.225/0.225/0.225
0.120/0.120/0.120	0.120/0.120/0.120	0.135/0.135/0.135	0.200/0.200/0.200	0.210/0.210/0.210	0.225/0.225/0.225
0.91/0.89/0.87	0.91/0.89/0.87	0.99/0.97/0.95	1.35/1.30/1.27	1.48/1.44/1.39	1.55/1.50/1.47
0.91/0.89/0.87	0.91/0.89/0.87	0.99/0.97/0.95	1.37/1.34/1.29	1.46/1.42/1.38	1.55/1.50/1.46
Sirocco fan	Sirocco fan	Sirocco fan	Sirocco fan	Sirocco fan	Sirocco fan
1,260/1,140/900	1,260/1,140/900	1,500/1,380/1,140	1,920/1,560/1,260	2,040/1,740/1,380	2,160/1,860/1,500
350/317/250	350/317/250	417/383/317	533/433/350	567/483/383	600/533/417
0.124	0.124	0.124	0.235	0.235	0.235
70(10-150)	70(10-150)	70(10-150)	100(10-150)	100(10-150)	100(10-150)
57/54/48	57/54/48	59/56/50	60/56/53	61/57/54	62/58/55
35/32/26	35/32/26	37/34/28	38/34/31	39/35/32	40/36/33
290x1,000x700	290x1,000x700	290x1,000x700	290x1,400x700	290x1,400x700	290x1,400x700
Ø9.52 (Ø3/8)	Ø9.52 (Ø3/8)	Ø9.52 (Ø3/8)	Ø9.52 (Ø3/8)	Ø9.52 (Ø3/8)	Ø9.52 (Ø3/8)
Ø15.88 (Ø5/8)	Ø15.88 (Ø5/8)	Ø15.88 (Ø5/8)	Ø15.88 (Ø5/8)	Ø15.88 (Ø5/8)	Ø15.88 (Ø5/8)
VP-25	VP-25	VP-25	VP-25	VP-25	VP-25
34	34	34	46	46	46

### SIZE 60-90

- 1 Refrigerant piping joint (liquid tube) Ø9.52 Flare
- 2 Refrigerant piping joint (gas tube) Ø15.88 Flare
- 3 Upper drain port VP25 (O.D. Ø32 mm)
- 4 Bottom drain port VP25 (O.D. Ø32 mm)
- 5 Suspension lug (4-12 × 30 mm)
- 6 Power supply outlet
- 7 Fresh air intake port (Ø150 mm)
- 8 Flange for flexible air outlet duct
- 9 Electrical component box

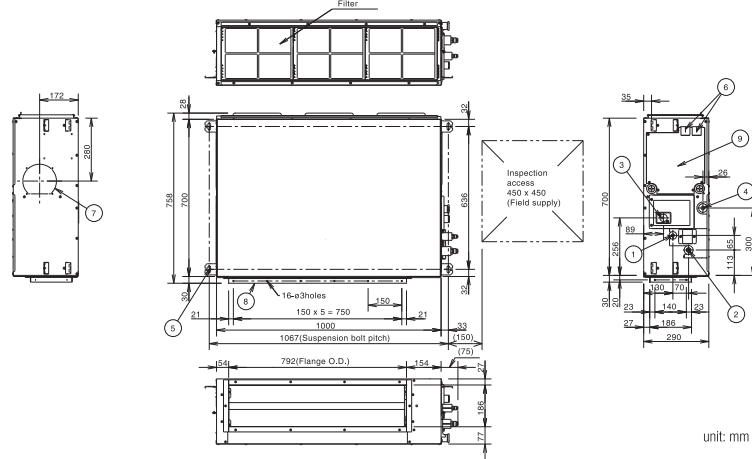

### SIZE 106-160

- 1 Refrigerant piping joint (liquid tube) Ø9.52 Flare
- 2 Refrigerant piping joint (gas tube) Ø15.88 Flare
- 3 Upper drain port VP25 (O.D. Ø32 mm)
- 4 Bottom drain port VP25 (O.D. Ø32 mm)
- 5 Suspension lug (4-12 × 30 mm)
- 6 Power supply outlet
- 7 Fresh air intake port (Ø150 mm)
- 8 Flange for flexible air outlet duct
- 9 Electrical component box

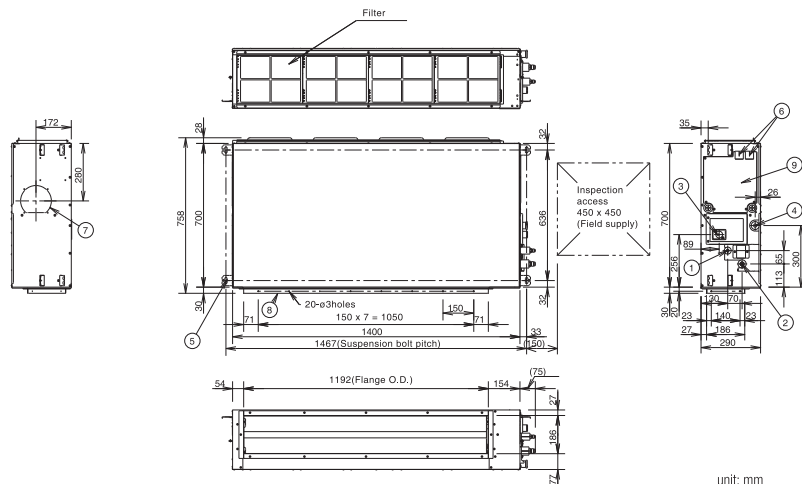



# M1<sup>TYPE</sup> Slim Low Static Ducted Concealed duct



The ultra slim M1 type is one of the leading products of its type in the industry. With a height of only 200 mm, it provides greater flexibility and adaptability for various applications. In addition, high efficiency and extreme low noise level make it highly suitable for hotels and small offices.



Self-diagnosing  
Function



Automatic  
Fan  
Operation



Mild dry



Automatic  
Restart  
Function



Built-in Drain  
Pump

## Technical focus

- Ultra-slim profile: 200 mm for all models
- DC fan motor greatly reduces power consumption
- Ideal for hotel application with very narrow false ceilings
- Anti-mould washable filters included
- Easy maintenance and service by external electrical box
- 40 Pa static pressure enables ductwork to be fitted.
- Includes drain pump

### Ultra-slim profile for all models

200mm height for all models allows installation in very narrow ceilings.



### Drain pump with increased power!

Using the built-in high-lift drain pump, the drain piping rise height can be increased to 653 mm from the lower surface of the body.

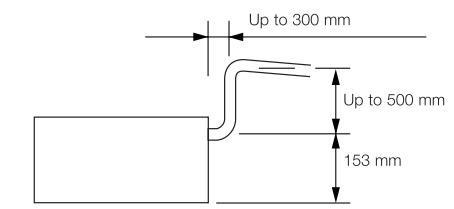



S-22MM1E5A / S-28MM1E5A / S-36MM1E5A  
S-45MM1E5A / S-56MM1E5A

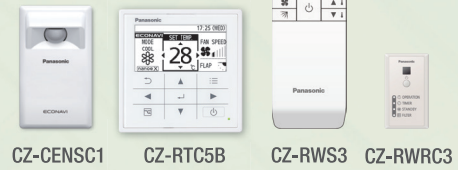

Model Name		S-22MM1E5A	S-28MM1E5A	S-36MM1E5A	S-45MM1E5A	S-56MM1E5A	
Power source		220/230/240 V, 1 phase - 50 / 60 Hz					
Cooling capacity	kW	2.2	2.8	3.6	4.5	5.6	
	BTU/h	7,500	9,600	12,300	15,400	19,100	
Heating capacity	kW	2.5	3.2	4.2	5.0	6.3	
	BTU/h	8,500	10,900	14,300	17,100	21,500	
Power input	Cooling kW	0.036/0.036/0.036	0.040/0.040/0.040	0.042/0.042/0.042	0.049/0.049/0.049	0.064/0.064/0.064	
	Heating kW	0.026/0.026/0.026	0.030/0.030/0.030	0.032/0.032/0.032	0.039/0.039/0.039	0.054/0.054/0.054	
Running current	Cooling A	0.26/0.26/0.26	0.30/0.30/0.30	0.31/0.31/0.31	0.37/0.37/0.37	0.48/0.48/0.48	
	Heating A	0.23/0.23/0.23	0.27/0.27/0.27	0.28/0.28/0.28	0.34/0.34/0.34	0.45/0.45/0.45	
Fan	Type	Sirocco fan	Sirocco fan	Sirocco fan	Sirocco fan	Sirocco fan	
	Air flow rate (H/M/L)	m³/h	480/420/360	510/450/390	540/480/420	630/570/480	750/690/600
		L/s	133/117/100	142/125/108	150/133/117	175/158/133	208/192/167
	Motor output	kW	0.06	0.06	0.06	0.06	0.06
	External static pressure	Pa	10 (30)	15 (30)	15 (40)	15 (40)	15 (40)
Sound power level (H/M/L)	dB	43/42/40	45/44/42	47/45/43	49/47/45	52/50/48	
Sound pressure level (H/M/L)	dB(A)	28/27/25 (30/29/27)*	30/29/27 (32/31/29)*	32/30/28 (34/32/30)*	34/32/30 (36/34/32)*	35/33/31 (37/35/32)*	
Dimensions	H x W x D	mm	200 x 750 x 640	200 x 750 x 640	200 x 750 x 640	200 x 750 x 640	
	Liquid	mm (inches)	Ø6.35 (Ø1/4)	Ø6.35 (Ø1/4)	Ø6.35 (Ø1/4)	Ø6.35 (Ø1/4)	
	Gas	mm (inches)	Ø12.7 (Ø1/2)	Ø12.7 (Ø1/2)	Ø12.7 (Ø1/2)	Ø12.7 (Ø1/2)	
Pipe connections	Drain piping		VP-20	VP-20	VP-20	VP-20	
Net weight	kg	19	19	19	19	19	

GLOBAL REMARKS	Rated conditions:	
	Cooling	Heating
	Indoor air temperature	27°C DB / 19°C WB
Outdoor air temperature	35°C DB / 24°C WB	7°C DB / 6°C WB

Specifications are subject to change without notice. \* With booster cable.

### M1 TYPE SLIM LOW STATIC DUCTED Dimensions

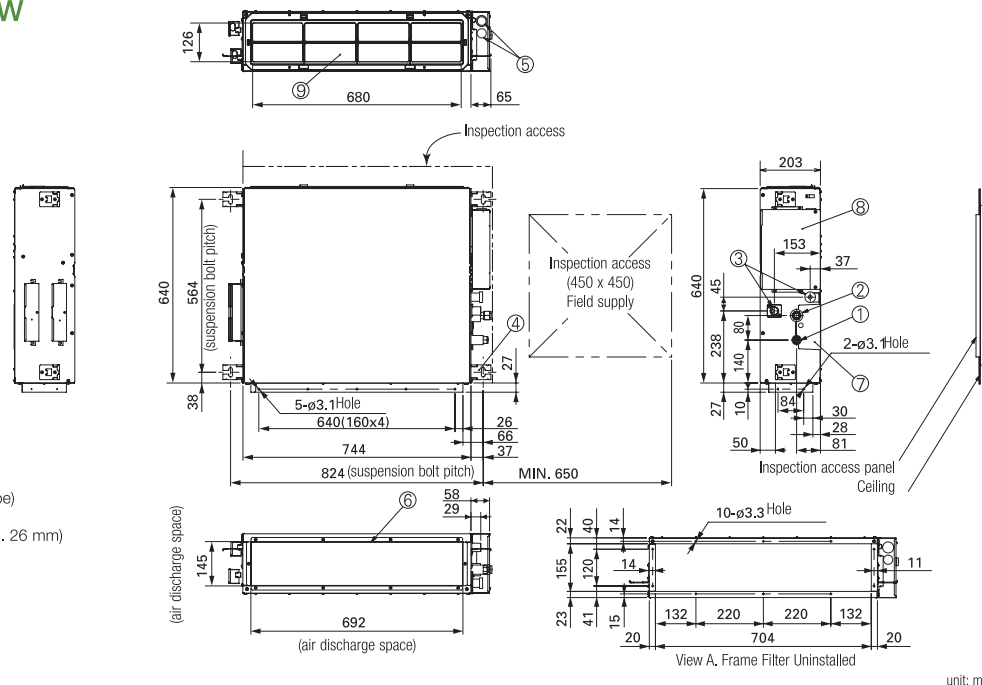

unit: mm

# Z1 TYPE Slim Low Static Ducted Twenty Series

## Concealed duct

The ultra slim Z1 type is one of the leading products of its type in the industry. With a height of only 200 mm, it provides greater flexibility and adaptability for various applications. In addition, high efficiency and extreme low noise level make it highly suitable for hotels and small offices.



Self-diagnosing  
Function



Automatic  
Fan  
Operation



Mild dry



Automatic  
Restart  
Function

### Technical focus

- Ultra-slim profile: 200 mm for all models
- DC fan motor greatly reduces power consumption
- Ideal for hotel application with very narrow false ceilings
- Easy maintenance and service by external electrical box
- 29 Pa static pressure enables ductwork to be fitted.
- Drain pump (optional)

### Ultra-slim profile for all models

200mm height for all models allows installation in very narrow ceilings.

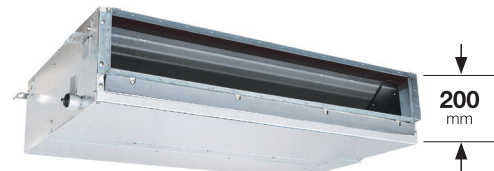

### Drain pump with increased power! (optional)

Using the optional high-lift drain pump, the drain piping rise height can be increased to 700 mm from the drain pipe port.

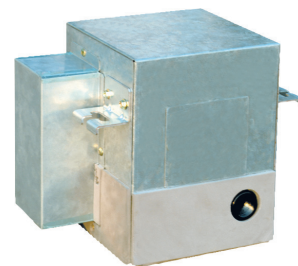

CZ-73DMZ1



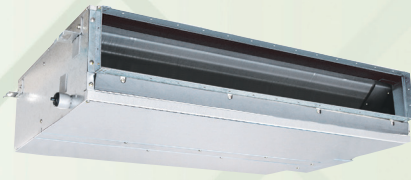

S-22MZ1H4A/ S-28MZ1H4A/ S-36MZ1H4A/  
S-45MZ1H4A/ S-56MZ1H4A/ S-60MZ1H4A

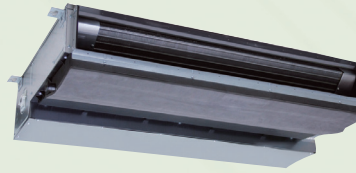

S-73MZ1H4A

**ECONAVI**  
ECONAVI ready



CZ-CENSC1



CZ-RTC5B



CZ-RWS3



CZ-RWRC3

Model Name		S-22MZ1H4A	S-28MZ1H4A	S-36MZ1H4A	S-45MZ1H4A	S-56MZ1H4A	S-60MZ1H4A	S-73MZ1H4A	
Power source		220/230/240 V, 1 phase - 50 / 60 Hz							
Cooling capacity	kW	2.2	2.8	3.6	4.5	5.6	6.0	7.3	
	BTU/h	7,500	9,500	12,200	15,300	19,100	20,500	24,900	
Heating capacity	kW	2.5	3.2	4.2	5.1	6.4	7.1	8.0	
	BTU/h	8,500	10,900	14,300	17,400	21,800	24,200	27,300	
Power input	Cooling kW	0.075/0.075/0.075	0.080/0.080/0.080	0.085/0.085/0.085	0.095/0.095/0.095	0.100/0.100/0.100	0.100/0.100/0.100	0.125/0.125/0.125	
	Heating kW	0.075/0.075/0.075	0.080/0.080/0.080	0.085/0.085/0.085	0.095/0.095/0.095	0.100/0.100/0.100	0.100/0.100/0.100	0.125/0.125/0.125	
Running current	Cooling A	0.50/0.47/0.45	0.55/0.52/0.50	0.60/0.57/0.55	0.70/0.68/0.65	0.75/0.72/0.70	0.75/0.72/0.70	0.80/0.78/0.75	
	Heating A	0.50/0.47/0.45	0.55/0.52/0.50	0.60/0.57/0.55	0.70/0.68/0.65	0.75/0.72/0.70	0.75/0.72/0.70	0.80/0.78/0.75	
Fan	Type	Sirroco fan	Sirroco fan	Sirroco fan	Sirroco fan	Sirroco fan	Sirroco fan	Sirroco fan	
	Air flow rate (H/M/L)	m <sup>3</sup> /h	480/420/360	600/540/420	600/540/420	690/630/510	720/660/540	870/750/630	1,080/840/660
		L/s	133/117/100	167/150/117	167/150/117	192/175/142	200/183/150	242/208/175	300/233/183
	Motor output	W	60	60	60	60	60	60	
	External static pressure	Pa	10-30	10-30	10-30	10-30	10-30	10-30	
Sound power level (H/M/L)	dB	50/49/47	52/51/49	54/52/50	56/54/52	57/55/53	60/57/55	62/60/58	
Sound pressure level (H/M/L)	dB(A)	28/27/25	30/29/27	32/30/28	34/32/30	35/33/31	38/35/33	40/38/36	
Dimensions	H x W x D	mm	200x830x500	200x830x500	200x830x500	200x830x500	200x830x500	200x1,050x550	
	Liquid	mm (inches)	Ø6.35 (Ø1/4)	Ø6.35 (Ø1/4)	Ø6.35 (Ø1/4)	Ø6.35 (Ø1/4)	Ø6.35 (Ø1/4)	Ø9.52 (Ø3/8)	
	Gas	mm (inches)	Ø12.7 (Ø1/2)	Ø12.7 (Ø1/2)	Ø12.7 (Ø1/2)	Ø12.7 (Ø1/2)	Ø12.7 (Ø1/2)	Ø15.88 (Ø5/8)	
Pipe connections	Drain piping		O.D. Ø20.5 mm / I.D. Ø15.5mm	O.D. Ø20.5 mm / I.D. Ø15.5mm	O.D. Ø20.5 mm / I.D. Ø15.5mm	O.D. Ø20.5 mm / I.D. Ø15.5mm	O.D. Ø20.5 mm / I.D. Ø15.5mm	O.D. Ø20.5 mm / I.D. Ø15.5mm	
	Net weight	kg	17	17	18	18	18	24	

GLOBAL REMARKS	Rated conditions:	Cooling	Heating
	Indoor air temperature	27°C DB / 19°C WB	20°C DB
	Outdoor air temperature	35°C DB / 24°C WB	7°C DB / 6°C WB

Specifications are subject to change without notice.

### Z1 TYPE SLIM LOW STATIC DUCTED TWENTY SERIES Dimensions

#### SIZE 22-60

#### SIZE 73

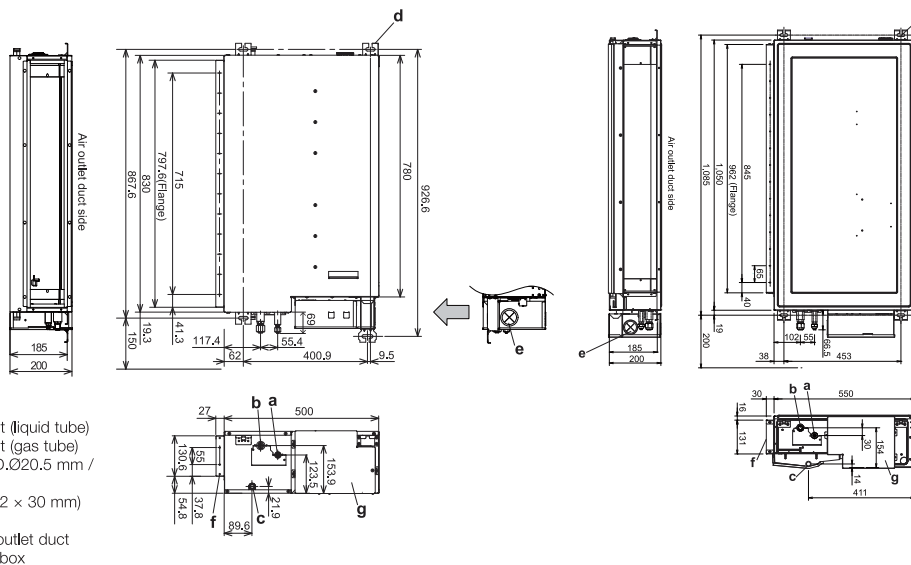

unit: mm

# E2 TYPE High Static Ducted



## Concealed duct / Air conditioning mode

High static and large airflow ducted for exceptional installation flexibility.



Self-diagnosing Function



Automatic Fan Operation



Mild dry



Automatic Restart Function

### Technical focus

- Design flexibility thanks to high static pressure and large air volume
- DC motor equipped
- Power input 45% less (compared to E1 type)
- Discharge air temperature control to reduce cold drafts during heating operation
- Configurable air temperature control
- Available Fresh Air Intake mode (See page 80-81)

### 3-step static pressure set up

You can select between the three Static Pressure modes of 270 Pa/140 Pa/60(72\*) Pa for extra installation flexibility.

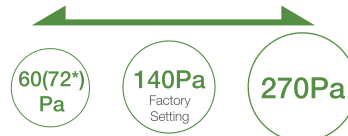

\* 28 kW model

### Max. 270 Pa static pressure setting

A maximum static pressure setting of a high 270 Pa enables the use of long ducts for installation in a wide range of spaces. Ideal for large-scale offices, restaurants and other facilities.

### Sensible cooling 5-10% improved

New heat exchanger with  $\phi$  7mm pipe that increases the heat transfer surface to improve sensible cooling (5-10% improvement)

### No Rap Valve Kit required

Thanks to improved performance, a Rap Valve Kit (CZ-P160RVK2) is no longer required.

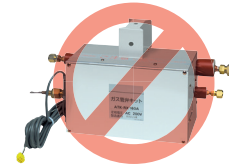

### Discharge air temperature control

- Equipped with 4 sensors (Intake/ Discharge)
- Able to control discharge air temperature for accurate room temperature control.
- Possible to reduce cold drafts during heating operation.

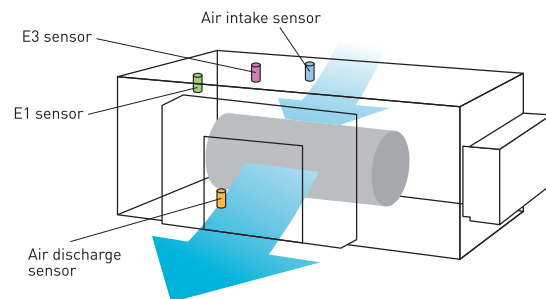



S-180ME2E5 / S-224ME2E5 / S-280ME2E5



CZ-RTC5B



CZ-RWS3



CZ-RWRC3

Model Name		S-180ME2E5	S-224ME2E5	S-280ME2E5	
Power source		220/230/240 V, 1 phase - 50Hz, 220/230 V, 1 phase - 60Hz			
Cooling capacity	kW	18.0	22.4	28.0	
	BTU/h	61,400	76,400	95,500	
Heating capacity	kW	20.0	25.0	31.5	
	BTU/h	68,200	85,300	107,500	
Power input	Cooling kW	0.400	0.440	0.715	
	Heating kW	0.400	0.440	0.715	
Running current	Cooling A	2.40/2.30/2.20	2.55/2.45/2.35	3.95/3.85/3.70	
	Heating A	2.40/2.30/2.20	2.55/2.45/2.35	3.95/3.85/3.70	
Fan	Type	Sirocco fan			
	Air flow rate (H/M/L)	m³/h	2,940/2,640/2,340	3,360/3,060/2,640	4,320/3,780/3,180
		L/s	817/733/650	933/850/733	1,200/1,050/883
	Motor output	kW			
	External static pressure	Pa	140 (60/270)	140 (60/270)	140 (72/270)
Sound power level (H/M/L)	dB	76/74/72	77/75/73	81/79/75	
Sound pressure level (H/M/L)	dB(A)	44/42/40	45/43/41	49/47/43	
Dimensions	H x W x D	mm			
	Pipe connections	Liquid inches (mm)	Ø9.52 (3/8)	Ø9.52 (3/8)	Ø9.52 (3/8)
	Gas inches (mm)	Ø19.05 (3/4)	Ø19.05 (3/4)	Ø22.22 (7/8)	
Drain piping		VP-25			
Net weight	kg	102	102	106	

GLOBAL REMARKS	Rated conditions:	
	Indoor air temperature	Cooling 27°C DB / 19°C WB Heating 20°C DB
	Outdoor air temperature	Cooling 35°C DB / 24°C WB Heating 7°C DB / 6°C WB

### E2 TYPE HIGH STATIC DUCTED Dimensions

- 1 Refrigerant piping (liquid pipes) Ø9.52
- 2 Refrigerant piping (gas pipes)  
180 & 224 type: Ø19.05, 280 type: Ø22.22
- 3 Power supply outlet (Ø25 grommet, rubber)
- 4 Power supply outlet (spare) (Ø30 knock-out)
- 5 Optional outlet for piping
- 6 Drain port 25 A, male thread
- 7 Duct connection for suction
- 8 Duct connection for discharge

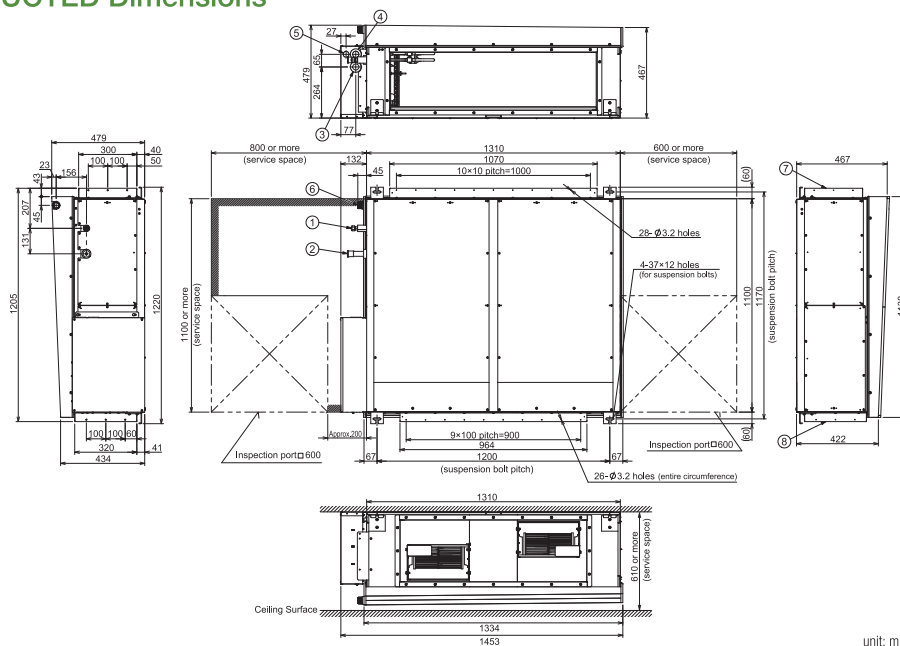

unit: mm



# E2 TYPE Energy Saving High Fresh Air Ducted



## Concealed duct high-static pressure

High static and large airflow ducted for exceptional installation flexibility.



Self-diagnosing Function



Automatic Fan Operation



Automatic Restart Function

### Technical focus

- 100% fresh air intake for ventilation purpose
- Design flexibility with high static pressure and large air volume
- DC motor equipped
- Power input 45% less (compared to H1 type)
- Discharge air temperature control to reduce cold drafts during heating operation
- Configurable air temperature control

### High Fresh System

High Fresh System enables delivery of fresh outside air at almost the same temperature and humidity as indoor air without putting a burden on air conditioning.

\* Capable of treating outdoor air only. Indoor air conditioner units are required to adjust indoor air temperature.

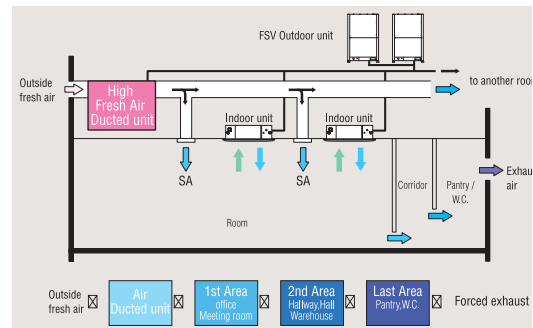

### Mix operation unit with standard indoor units

Possible to combine High Fresh Air ducted indoor unit and standard air ducted indoor units. When other indoor units are connected in same circuit, keep following capacity ratio. E2 type/Outdoor unit < 30%, and Total of indoors(incl. E2)/outdoor < 100%

### Discharge air temperature control

- Equipped with 4 sensors (Intake/ Discharge)
- Able to control discharge air temperature for accurate room temperature control.
- Possible to reduce cold drafts during heating operation.

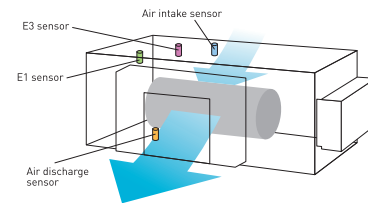

### Remark For High Static Ducted Series

Model	Operation	Rap valve kit CZ-P160RVK2	3way control PCB CZ-CAPE2	3way valve kit CZ-P160HR3	Distribution Joint kit <2pipes> CZ-P160BK2 for 22.4kW unit or less CZ-P680BK2 for more than 22.4kW	Distribution Joint kit <3pipes> CZ-P224BH2 for 22.4kW unit CZ-P680BH2 for 28.0kW unit
E2 Type Energy Saving High-Fresh Air Ducted	Cooling Only	-	-	-	-	-
	Cool or Heat	2pcs	2pcs	-	2pcs	-
	Heat Recovery	-	2pcs	2pcs	1pc	1pc



S-224ME2E5 /  
S-280ME2E5



CZ-RTC5B



CZ-RWS3



CZ-RWRC3

Model Name		S-224ME2E5	S-280ME2E5	
Power source		220/230/240 V, 1 phase - 50Hz, 220/230 V, 1 phase - 60Hz		
Cooling capacity	kW	22.4	28.0	
	BTU/h	76,400	95,500	
Heating capacity	kW	21.2	26.5	
	BTU/h	72,300	90,400	
Power input	Cooling kW	0.290	0.350	
	Heating kW	0.290	0.350	
Running current	Cooling A	1.90/1.85/1.80	2.30/2.20/2.10	
	Heating A	1.90/1.85/1.80	2.30/2.20/2.10	
Fan	Type	Sirocco fan	Sirocco fan	
	Air flow rate	m³/h	1,700	2,100
		L/s	472	583
	Motor output	kW	0.560 x 2	0.750 x 2
	External static pressure	Pa	200	200
Sound power level		dB	75	76
Sound pressure level		dB(A)	43	44
Dimensions	H x W x D	mm	479 x 1,453 x 1,205	479 x 1,453 x 1,205
	Liquid	inches (mm)	Ø9.52 (Ø3/8)	Ø9.52 (Ø3/8)
Pipe connections	Gas	inches (mm)	Ø19.05 (Ø3/4)	Ø22.22 (Ø7/8)
	Drain piping		VP-25	VP-25
Net weight		kg	102	106

GLOBAL	Rated conditions:	Cooling	Heating	Specifications are subject to change without notice.
REMARKS	Outdoor air temperature	33°C DB / 28°C WB	0°C DB / -2.9°C WB	

### E2 TYPE HIGH STATIC DUCTED Dimensions

- 1 Refrigerant piping (liquid pipes) Ø9.52
- 2 Refrigerant piping (gas pipes)  
224 type: Ø19.05, 280 type: Ø22.22
- 3 Power supply outlet (Ø25 grommet, rubber)
- 4 Power supply outlet (spare) (Ø30 knock-out)
- 5 Optional outlet for piping
- 6 Drain port 25 A, male thread
- 7 Duct connection for suction
- 8 Duct connection for discharge

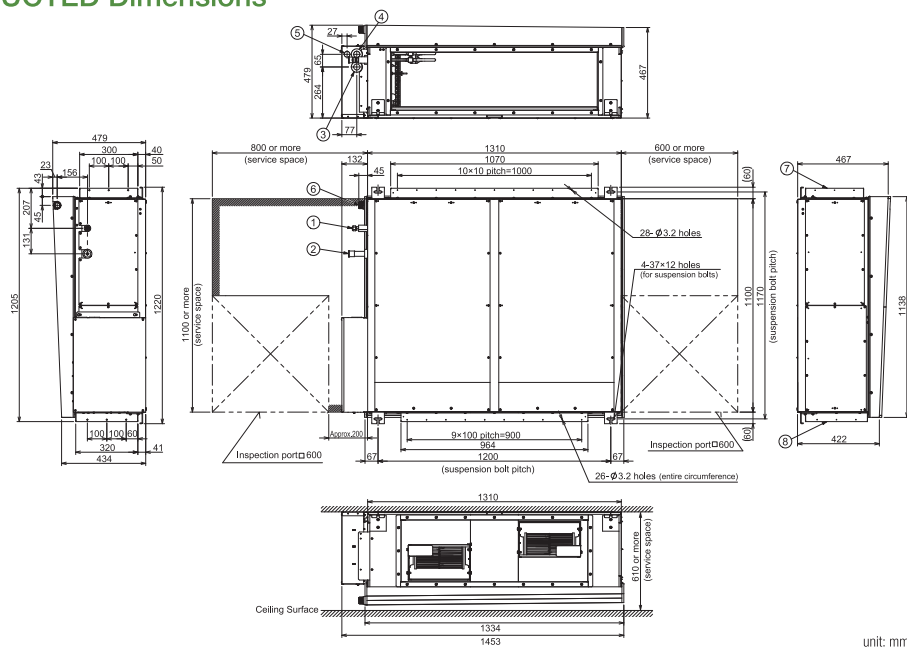

unit: mm

# H1 TYPE High-Fresh Air Ducted

## Concealed duct

High static and large airflow ducted for exceptional installation flexibility.



Self-diagnosing Function



Automatic Fan Operation



Automatic Restart Function

### Technical focus

- 100% fresh Air intake for ventilation purpose
- Design flexibility thanks to high static pressure and large air volume
- Discharge air temperature control to reduce cold drafts during heating operation
- Configurable air temperature control

### High Fresh System

High Fresh system enables delivery of fresh outside air at almost the same temperature and humidity as indoor air without putting a burden on air conditioning.

\* Capable of treating outdoor air only. Indoor air conditioner units are required to adjust indoor air temperature.

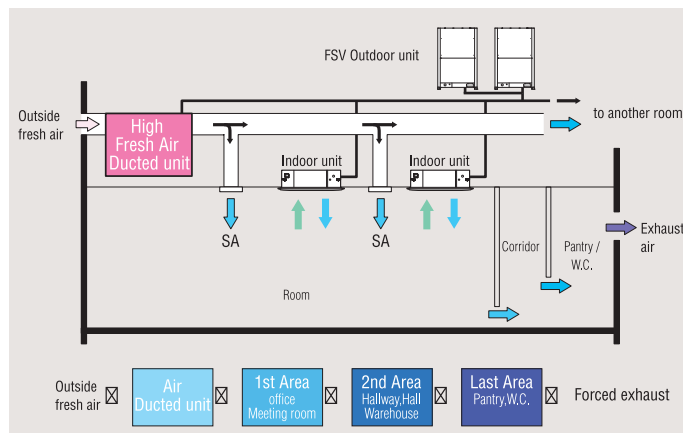

### Mix operation unit with standard indoor units

Possible to combine High Fresh Air ducted indoor unit and standard air ducted indoor units.

When other indoor units are connected in same circuit, keep following capacity ratio.

H1 type/Outdoor unit < 30%, and Total of indoors(incl. H1)/outdoor < 100%

### Remark For High Static Ducted Series

Model	Operation	Rap valve kit <b>CZ-P160RVK2</b> 	3way control PCB <b>CZ-CAPE2</b> 	3way valve kit <b>CZ-P160HR3</b> 	Distribution Joint kit <2pipes> <b>CZ-P160BK2</b> for 22.4kW unit or less <b>CZ-P680BK2</b> for more than 22.4kW	Distribution Joint kit <3pipes> <b>CZ-P224BH2</b> for 22.4kW unit <b>CZ-P680BH2</b> for 28.0kW unit
H1 Type <b>High-Fresh Air Ducted</b>	Cooling Only	-	-	-	-	-
	Cool or Heat	2pcs	-	-	2pcs	-
	Heat Recovery	-	-	2pcs	1pc	1pc





Model Name		S-140MH1H5	S-224MH1H5	S-280MH1H5
Power source		220/230/240 V, 1 phase - 50Hz		
Cooling capacity	kW	14.0	22.4	28.0
	BTU/h	47,800	76,400	95,500
Heating capacity	kW	13.2	21.2	26.5
	BTU/h	45,000	72,300	90,400
Power input	Cooling kW	0.430/0.430/0.430	0.670/0.670/0.670	0.730/0.730/0.730
	Heating kW	0.430/0.430/0.430	0.670/0.670/0.670	0.730/0.730/0.730
Running current	Cooling A	2.0/1.9/1.9	3.2/3.1/3.0	3.6/3.4/3.3
	Heating A	2.0/1.9/1.9	3.2/3.1/3.0	3.6/3.4/3.3
Fan	Type	Sirocco fan		
	Air flow rate m³/h	1,560	1,800	2,100
	L/s	433	500	583
	Motor output kW	0.3	0.38	0.38
Sound power level (H/M/L)	dB	75/76/76	78/79/79	79/80/80
Sound pressure level (H/M/L)	dB(A)	43/44/44	46/47/47	47/48/48
Dimensions	H x W x D mm	420 x 1,065 x 620	479 x 1,428 x 1,230	479 x 1,428 x 1,230
	Liquid mm (inches)	Ø9.52 (Ø3/8)	Ø12.7 (Ø1/2)	Ø12.7 (Ø1/2)
Pipe connections	Gas mm (inches)	Ø15.88 (Ø5/8)	Ø25.4 (Ø1)	Ø25.4 (Ø1)
	Drain piping	VP-25		
Net weight	kg	50	110	110

GLOBAL REMARKS	Rated conditions:	Cooling	Heating	Specifications are subject to change without notice.
	Outdoor air temperature	33°C DB / 28°C WB	0°C DB / -2.9°C WB	

### H1TYPE HIGH-FRESH AIR DUCTED Dimensions

- 1 Refrigerant liquid line
- 2 Refrigerant gas line
- 3 Power supply entry
- 4 Drain connection
- 5 Duct connection for suction
- 6 Duct connection for discharge

#### SIZE 140

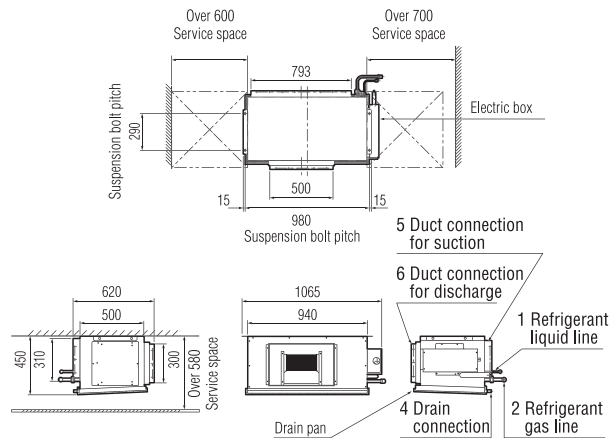

#### SIZE 224-280

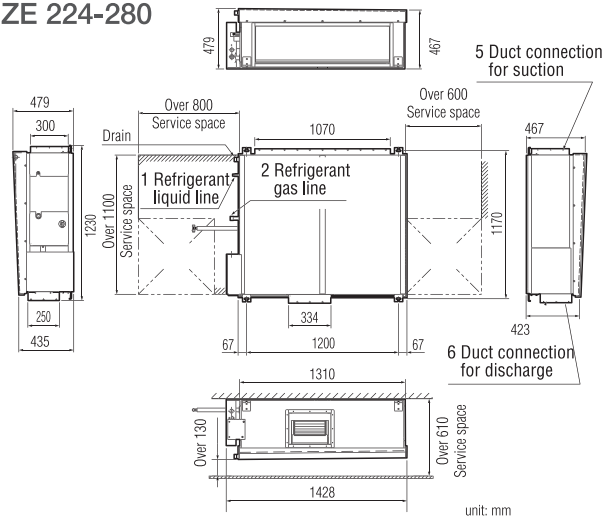

# K2<sub>TYPE</sub> Wall Mounted



The K2 type wall mounted unit has a stylish smooth design with a washable front panel. Small, lightweight and low noise level makes it ideal for small offices and other commercial applications.



Self-diagnosing Function



Automatic Fan Operation



Mild dry



Intelligent Auto Swing



Automatic Restart Function



Auto Swing (Auto Flap Control)

## Technical focus

- Closed discharge port when not in use
- Lighter and smaller units make installation easy
- Quiet operation
- Smooth and durable design
- Piping outlet in six directions
- Washable front panel
- Air distribution is automatically altered depending on the operational mode of the unit
- Anti-mould washable filters are included

## Noise reducing external valve kit

To reduce noise level of expansion valve.  
(Optional accessory)



CZ-P56SVK2 (for 22 - 56 type)  
CZ-P160SVK2 (for 73 - 106 type)

## Closed discharge port

When the unit is turned off, the flap closes completely to prevent entry of dust into the unit and to keep the equipment clean.

## Compact indoor units make the installation easy

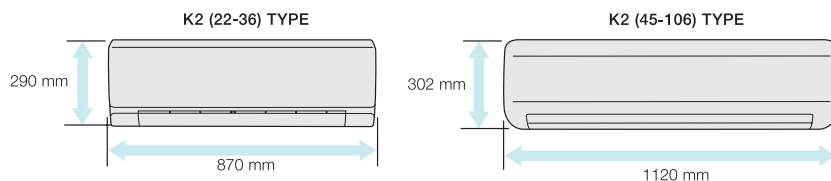



S-22MK2E5A / S-28MK2E5A / S-36MK2E5A



S-45MK2E5A / S-56MK2E5A / S-73MK2E5A / S-106MK2E5A

**ECONAVI**  
ECONAVI ready



CZ-CENSC1



CZ-RTC5B

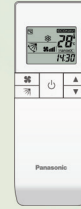

CZ-RWS3

### Quiet operation

Low operating noise level makes these units ideal for hotels and hospital applications.

### Smooth and durable design

The smooth cover means these units match most modern interiors. Their compact size enables them to blend in, even in small spaces.

### Piping outlet in six directions

Piping outlet is possible in the six directions of right, right rear, right bottom, left, left rear, left bottom, making installation easier.

### Washable front panel

The indoor unit's front panel can be easily removed and washed for trouble-free maintenance.



### Air distribution is automatically adjusted depending on the operational mode of the unit

Air outlet angle is automatically adjusted for cooling and heating operation.

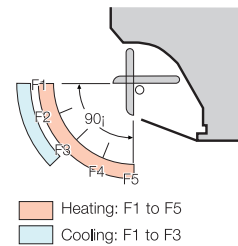



**K2<sub>TYPE</sub>** Wall Mounted

Model Name			S-22MK2E5A	S-28MK2E5A	S-36MK2E5A	S-45MK2E5A
Power source			220/230/240 V, 1 phase - 50 / 60 Hz			
Cooling capacity	kW		2.20	2.80	3.60	4.5
	BTU/h		7,500	9,600	12,300	15,400
Heating capacity	kW		2.50	3.20	4.20	5.0
	BTU/h		8,500	10,900	14,300	17,100
Power input	Cooling	kW	0.025/0.025/0.025	0.025/0.025/0.025	0.030/0.030/0.030	0.030/0.030/0.030
	Heating	kW	0.025/0.025/0.025	0.025/0.025/0.025	0.030/0.030/0.030	0.030/0.030/0.030
Running current	Cooling	A	0.21	0.23	0.25	0.33/0.32/0.31
	Heating	A	0.21	0.23	0.25	0.33/0.32/0.31
Fan	Type		Cross-flow fan	Cross-flow fan	Cross-flow fan	Cross-flow fan
	Air flow rate (H/M/L)	m <sup>3</sup> /h	540/450/390	570/498/390	654/540/390	870/750/600
		L/s	150/125/108	158/138/108	182/150/108	242/208/167
	Motor output	kW	0.03	0.03	0.03	0.054
Sound power level (H/M/L)	dB	51/48/44	52/49/44	55/51/44	53/50/48	
Sound pressure level (H/M/L)	dB(A)	36/33/29	37/34/29	40/36/29	38/35/33	
Dimensions	H x W x D	mm	290 x 870 x 214	290 x 870 x 214	290 x 870 x 214	302 x 1,120 x 236
Pipe connections	Liquid	mm (inches)	Ø6.35 (Ø1/4)	Ø6.35 (Ø1/4)	Ø6.35 (Ø1/4)	Ø6.35 (Ø1/4)
	Gas	mm (inches)	Ø12.7 (Ø1/2)	Ø12.7 (Ø1/2)	Ø12.7 (Ø1/2)	Ø12.7 (Ø1/2)
	Drain piping	mm	Ø18	Ø18	Ø18	Ø18
Net weight	kg		9	9	9	13

GLOBAL REMARKS	Rated conditions:		
	Indoor air temperature	Cooling 27°C DB / 19°C WB	Heating 20°C DB
	Outdoor air temperature	35°C DB / 24°C WB	7°C DB / 6°C WB

Specifications are subject to change without notice.

**K2 (22-36) TYPE WALL MOUNTED Dimensions**

**SIZE 22-36**

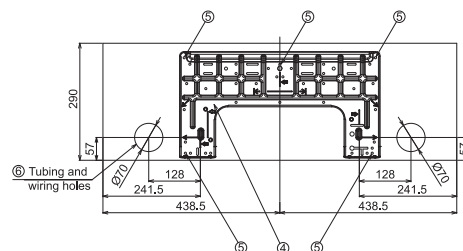
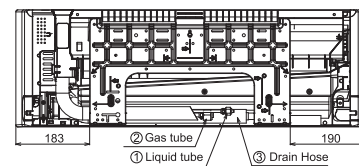
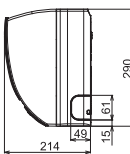
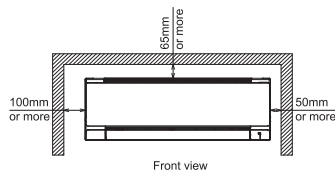
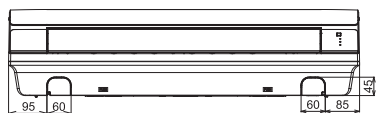
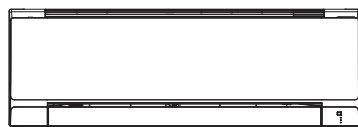
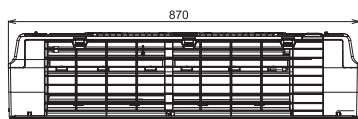

- 1 Refrigerant tubing (liquid tube) ø6.35(flared)
- 2 Refrigerant tubing (gas tube) ø12.7(flared)
- 3 Drain hose (outer dia. ø16)
- 4 Rear panel (PL BACK)
- 5 Rear panel fixing holes (ø5 holes or 5X13 oval holes)
- 6 Tubing and wiring holes (ø70)

unit: mm

S-56MK2E5A	S-73MK2E5A	S-106MK2E5A
220/230/240 V, 1 phase - 50 / 60 Hz		
5.6	7.3	10.6
19,100	24,900	36,200
6.3	8.0	11.4
21,500	27,300	38,900
0.035/0.035/0.035	0.055/0.055/0.055	0.080/0.080/0.080
0.035/0.035/0.035	0.055/0.055/0.055	0.080/0.080/0.080
0.36/0.35/0.34	0.52/0.51/0.50	0.72/0.70/0.68
0.36/0.35/0.34	0.52/0.51/0.50	0.72/0.70/0.68
Cross-flow fan	Cross-flow fan	Cross-flow fan
960/840/720	1,170/1,020/840	1,290/1,110/900
267/233/200	325/283/233	358/308/250
0.054	0.054	0.054
55/52/50	62/59/55	64/61/57
40/37/35	47/44/40	49/46/42
302 x 1,120 x 236	302 x 1,120 x 236	302 x 1,120 x 236
Ø6.35 (Ø1/4)	Ø9.52 (Ø3/8)	Ø9.52 (Ø3/8)
Ø12.7 (Ø1/2)	Ø15.88 (Ø5/8)	Ø15.88 (Ø5/8)
Ø18	Ø18	Ø18
13	14	14

## K2 (45-106) TYPE WALL MOUNTED Dimensions

### SIZE 45-106

- 1 Refrigerant tubing (liquid tube) Type 45-56 Ø6.35 (flared) Type 73-106 Ø9.52 (flared)
- 2 Refrigerant tubing (gas tube) Type 45-56 Ø12.7 (flared) Type 73-106 Ø15.88 (flared)
- 3 Drain hose
- 4 Rear panel
- 5 Rear panel fixing holes (Ø5.3 holes or as shown in figure "C")
- 6 Tubing and wiring holes (Ø80)

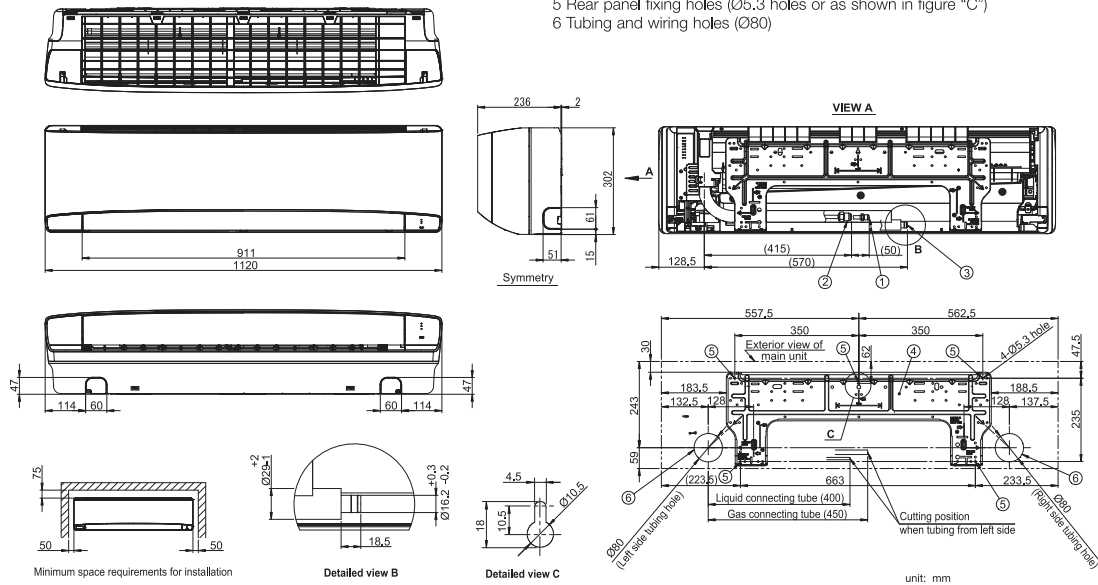

# U2<sub>TYPE</sub> 4-Way Cassette

## Semi concealed cassette



Provides a neat fit in the ceiling to match modern décor, and uniform cooling through out the room, and easy installation.

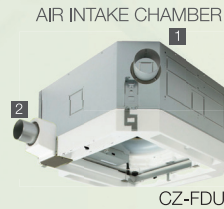

- 1 [1] Air intake flange (Ø100) (field supply)
- 2 Air intake box CZ-ATU2 \*
- 3 Air intake plenum CZ-FDU3

\* When using Air intake box (CZ-ATU2), Air intake plenum (CZ-FDU3) is required.

NEW PANEL DESIGN  
Flat design, well-matched with interior, building.



Normal Panel: CZ-KPU3H  
ECONAVI Panel: CZ-KPU3A



Self-diagnosing Function



Automatic Fan Operation



Mild dry



Intelligent Auto Swing



Automatic Restart Function



Auto Swing (Auto Flap Control)



Built-in Drain Pump

### Technical focus

- New high performance turbo fan, new path system for heat exchanger
- Lower noise in slow fan operation
- Industry top light weight, easy piping
- Easy installation structure of the panel
- Econavi: Floor temperature and human sensor added. Activity amount detection and new circulator
- nanoe™: The first 10x for CAC (10 times more nanoe™ particle for wide commercial space). Inside cleaning by 10x nanoe™ + dry control

### Flat Horizontal Design

The horizontal design of 4-way cassette achieves an elegant designed panel. Its slim design allow to protrude 33.5mm from the ceiling.



### Drain pump of up to 850 mm from the ceiling surface

Built in drain pump allows flexible install and design options with up to 850mm lift. Long horizontal piping is also possible.

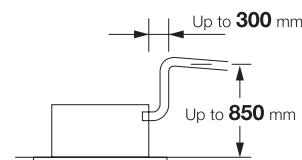

### Easy to clean suction grille

Suction grille is able to make 90-degree turns.

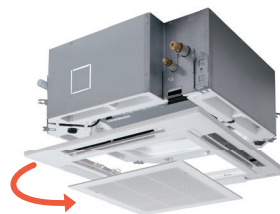

### 360° Wide & Comfortable Airflow

Comfort air flow control and proper energy use. Flexible Air Flow direction control by individual flap control:

- 4 Flaps can be controlled individually (by standard wired remote controller\*)
- Versatile air flow control to cover a wide variety of demands.

Ample airflow: 36 m<sup>3</sup>/min  
Industry's leading in the 140PU class.

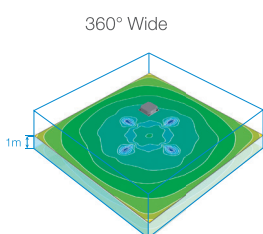
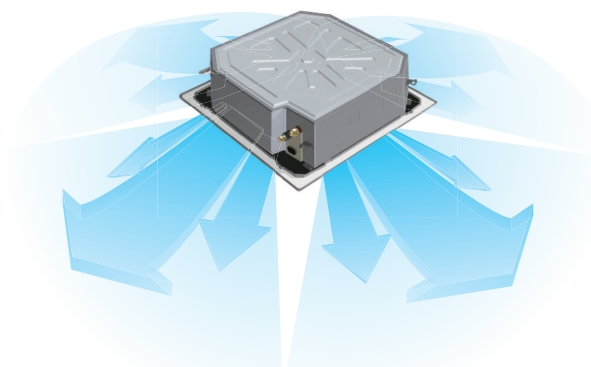

Temperature distribution by thermograph (cooling operation)



Simulation conditions:  
140M 4-way ceiling-mounted cassette type in cooling mode  
/ Floor area of 225 m<sup>2</sup>  
/ Ceiling height of 3 m

\*Pre-setting is required for this function at System Test-run procedure





**ECONAVI**  
ECONAVI ready



CZ-RTC5B

**nanoe™X**  
Required Kit



CZ-CNEXU1  
[CZ-RTC5B is required]

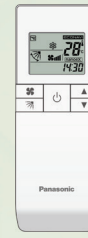

CZ-RWS3



CZ-RWRU3

### High-ceiling installation (Up to 5 m for 10.6 kW and higher capacity models)

The units can be installed in rooms with high ceilings, where they provide ample floor-level heating in the winter. (See ceiling height guidelines below.)

High Ceiling (Factory settings)

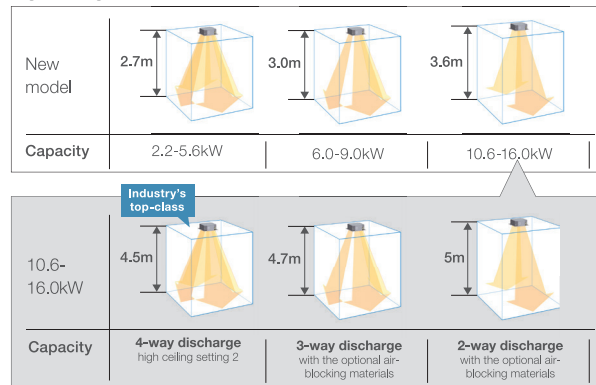

### Ceiling height guidelines

Indoor unit	*1 settings			3-way discharge (optional air-blocking materials)	2-way discharge (optional air-blocking materials) *2
	4-way discharge Factory setting 1	High ceiling setting 1	High ceiling setting 2		
2.2-5.6kW	2.7	3.2	3.5	3.8	4.2
6.0-9.0kW	3.0	3.3	3.6	3.8	4.2
10.6-16.0kW	3.6	4.3	5.0	4.7	5.0

\*1 When using the unit in a configuration other than the factory settings, it is necessary to make settings on site to increase airflow.

\*2 Use air-blocking materials (CZ-CFU3) to completely block two discharge outlets for 2-way airflow.

### Econavi panel is added into the line up

Continue Conventional function (Energy saving & comfort) and following are newly added.

- Energy saving function: comfortable energy saving based on temperature and humidity

- New circulate function that improves comfort
- Movement detection is improved improving comfort

### Econavi energy saving function

Newly put humidity sensor on air suction part, and achieve more comfort and energy saving operation.

- Energy saving operation in case of low humidity during cooling operation

- Energy saving operation in case of high humidity during heating operation

Energy saving operation based on activity amount and comfort and energy saving based on temperature and humidity.

### Panels & Panel parts

Normal panel: CZ-KPU3H  
Econavi panel: CZ-KPU3A

Wireless receiver (option)



Econavi panel

**nanoe™X** [Optional]

### nanoe™X with 10 Times the Concentration

nanoe™ X contains plenty of OH radicals that have outstanding effects on various air pollutants, including bacteria and viruses, mould, allergens, pollen, hazardous substances, as well as deodorise odours.

It also keeps moisture in your skin and hair.

\*CZ-CNEXU1 is required to use nanoe™ X function.

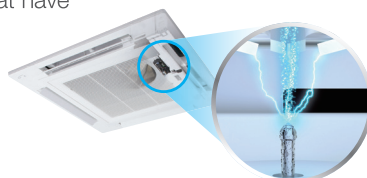

Invisible Air Contaminants are Suppressed.

- Odours
- Bacteria and Viruses
- Mould
- Allergens
- Pollen
- Hazardous Substances
- Skin and Hair

# U2<sub>TYPE</sub> 4-Way Cassette

Model Name			S-22MU2E5A	S-28MU2E5A	S-36MU2E5A	S-45MU2E5A	S-56MU2E5A
Power source			220/230/240 V, 1 phase - 50Hz/60Hz				
Cooling capacity	kW		2.2	2.8	3.6	4.5	5.6
	BTU/h		7,500	9,600	12,300	15,400	19,100
Heating capacity	kW		2.5	3.2	4.2	5.0	6.3
	BTU/h		8,500	10,900	14,300	17,100	21,500
Power input	Cooling	kW	0.020/0.020/0.020	0.020/0.020/0.020	0.020/0.020/0.020	0.020/0.020/0.020	0.025/0.025/0.025
	Heating	kW	0.020/0.020/0.020	0.020/0.020/0.020	0.020/0.020/0.020	0.020/0.020/0.020	0.025/0.025/0.025
Running current	Cooling	A	0.21/0.21/0.20	0.21/0.21/0.20	0.21/0.21/0.20	0.21/0.21/0.20	0.24/0.23/0.22
	Heating	A	0.20/0.20/0.19	0.20/0.20/0.19	0.20/0.20/0.19	0.20/0.20/0.19	0.23/0.22/0.21
Fan	Type		Turbo fan	Turbo fan	Turbo fan	Turbo fan	Turbo fan
	Air flow rate (H/M/L)	m <sup>3</sup> /h	870/780/690	870/780/690	870/780/690	930/780/690	990/810/690
		L/s	242/217/192	242/217/192	242/217/192	258/217/192	275/225/192
	Motor output	kW	0.06	0.06	0.06	0.06	0.06
Sound power level (H/M/L)	dB	45/44/43	45/44/43	45/44/43	46/44/43	47/45/43	
Sound pressure level (H/M/L)	dB(A)	30/29/28	30/29/28	30/29/28	31/29/28	32/30/28	
Dimensions	H x W x D	mm	256+(33.5) x 840 (950) x 840 (950)				
Pipe connections	Liquid	mm (inches)	Ø6.35 (Ø1/4)	Ø6.35 (Ø1/4)	Ø6.35 (Ø1/4)	Ø6.35 (Ø1/4)	Ø6.35 (Ø1/4)
	Gas	mm (inches)	Ø12.7 (Ø1/2)	Ø12.7 (Ø1/2)	Ø12.7 (Ø1/2)	Ø12.7 (Ø1/2)	Ø12.7 (Ø1/2)
	Drain piping		VP-25	VP-25	VP-25	VP-25	VP-25
Net weight (Panel)	kg		19 (+5)	19 (+5)	19 (+5)	19 (+5)	19 (+5)

GLOBAL REMARKS	Rated conditions:	
	Cooling	Heating
	Indoor air temperature	27°C DB / 19°C WB
Outdoor air temperature	35°C DB / 24°C WB	7°C DB / 6°C WB

Specifications are subject to change without notice.



## Test report for odours and mould suppression performance

No.	Target Substance	Effectiveness	Testing Institute	Test Report No.	Method	Result
1	Odours	Decrease by 0.7 level	Gunma Research Center	Test Report No. 27055	nanoe <sup>TM</sup> X was operated in a test space (55m <sup>2</sup> ) and the deodorisation effect on a piece of cloth impregnated with odour components of cigarette smoke was evaluated using 6 level odor intensity indication method.	Decrease in odour intensity by 0.7 level after 2 hour of operation
2	Mould	Inhibit Mould Growth	Institute of Environmental Biology	Test Report No.150901, 150904	Mould sensor was attached at indoor unit inside. In a test space (95m <sup>2</sup> ) at 25 degree and 75% humidity, AC cooling with nanoe <sup>TM</sup> X was operated during 2 hour per day for 9 days.	No Mould Growth after 9 days.



S-60MU2E5A	S-73MU2E5A	S-90MU2E5A	S-106MU2E5A	S-140MU2E5A	S-160MU2E5A
220/230/240 V, 1 phase - 50Hz/60Hz					
6.0	7.3	9.0	10.6	14.0	16.0
20,500	24,900	30,700	36,200	47,800	54,600
7.1	8.0	10.0	11.4	16.0	18.0
24,200	27,300	34,100	38,900	54,600	61,400
0.035/0.035/0.035	0.040/0.040/0.040	0.040/0.040/0.040	0.090/0.090/0.090	0.095/0.095/0.095	0.105/0.105/0.105
0.035/0.035/0.035	0.040/0.040/0.040	0.040/0.040/0.040	0.085/0.085/0.085	0.090/0.090/0.090	0.100/0.100/0.100
0.34/0.33/0.32	0.37/0.36/0.35	0.39/0.38/0.37	0.74/0.71/0.68	0.77/0.74/0.71	0.85/0.82/0.79
0.33/0.32/0.31	0.36/0.35/0.34	0.38/0.37/0.36	0.72/0.69/0.66	0.75/0.72/0.69	0.83/0.80/0.77
Turbo fan	Turbo fan	Turbo fan	Turbo fan	Turbo fan	Turbo fan
1,260/960/780	1,350/960/780	1,380/1,110/840	2,040/1,500/1,140	2,160/1,560/1,200	2,220/1,680/1,440
350/267/217	375/267/217	383/308/233	567/417/317	600/433/333	617/467/400
0.06	0.06	0.06	0.09	0.09	0.09
51/47/44	52/47/44	53/50/47	59/53/49	60/54/50	61/55/53
36/32/29	37/32/29	38/35/32	44/38/34	45/39/35	46/40/38
319+(33.5 x 840 (950) x 840 (950)					
Ø9.52 (Ø3/8)	Ø9.52 (Ø3/8)	Ø9.52 (Ø3/8)	Ø9.52 (Ø3/8)	Ø9.52 (Ø3/8)	Ø9.52 (Ø3/8)
Ø15.88 (Ø5/8)	Ø15.88 (Ø5/8)	Ø15.88 (Ø5/8)	Ø15.88 (Ø5/8)	Ø15.88 (Ø5/8)	Ø15.88 (Ø5/8)
VP-25	VP-25	VP-25	VP-25	VP-25	VP-25
20 (+5)	20 (+5)	20 (+5)	25 (+5)	25 (+5)	25 (+5)

### U2 TYPE 4-WAY CASSETTE Dimensions

- 1 Air intake
- 2 Discharge outlet
- 3 Refrigerant tubing (liquid tube) 22-56 type ø6.35 (flared), 60-90 type ø9.52 (flared)
- 4 Refrigerant tubing (gas tube) 22-56 type ø12.7 (flared), 60-90 type ø15.88 (flared)
- 5 Drain tube connection port VP25 (outer dia. ø32)
- 6 Power supply port
- 7 Discharge duct connection port (ø150)
- 8 Suspension bolt hole (4-12x30 elongated hole)
- 9 Fresh air intake duct connection port (ø100) \*
- 10 ECONAVI sensor (Only CZ-KPU3A)

\*1: Necessary to attach duct connecting flange (field supplied).  
Filter size: 520 x 520 x 15

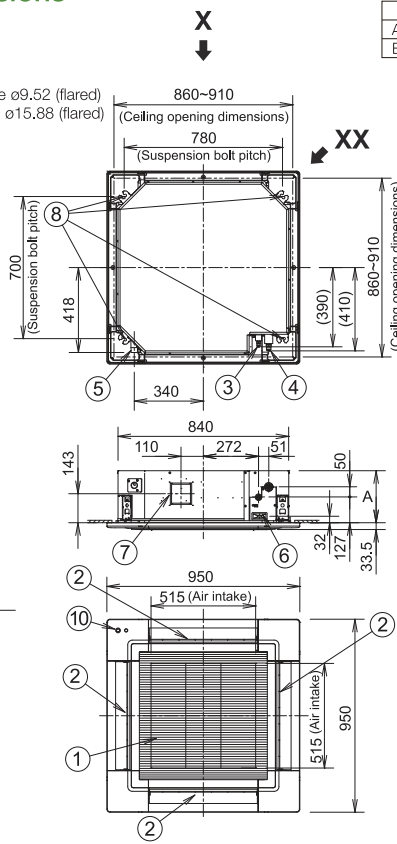
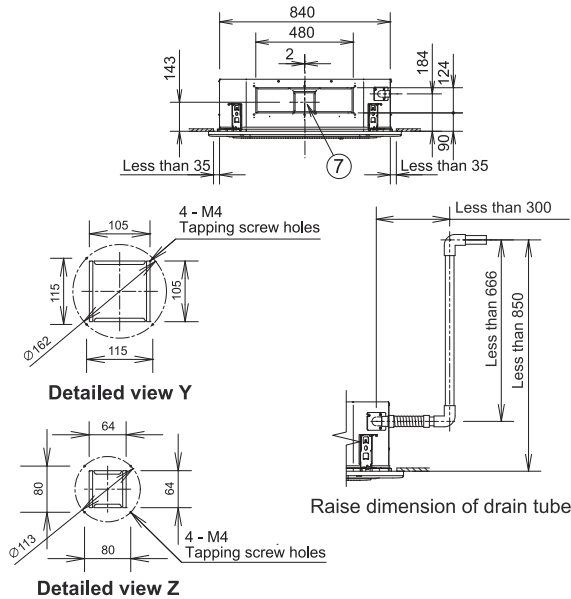

	22~90 type	106~160 type
A	256	319
B	124	187

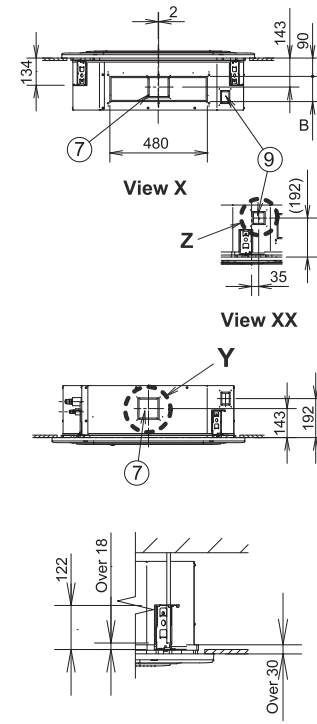

unit: mm

The length of the suspension bolts should be selected so that there is a gap of 30 mm or more below the lower surface of the ceiling (18 mm or more below the lower surface of the main unit), as shown in the figure at right. If the suspension bolt is too long, it will contact the ceiling panel and the unit cannot be installed.



# Y2<sub>TYPE</sub> 4-Way Mini Cassette

## Mini semi concealed cassette



Designed to fit perfectly into a 60 x 60 cm ceiling grid without the need to alter the bar configuration, the Y2 is ideal for small commercial and retrofit applications. In addition, improvements to the Y2's efficiency make this model one of the most advanced units in the industry.



Self-diagnosing Function



Automatic Fan Operation



Mild dry



Intelligent Auto Swing



Automatic Restart Function



Auto Swing (Auto Flap Control)



Built-in Drain Pump

### Technical focus

- Mini cassette fits into a 60 x 60 cm ceiling grid
- Anti-mould and anti-bacteria washable filters
- Powerful drain pump gives 750 mm lift
- DC fan motor with variable speed and a new heat exchanger ensures efficient power consumption
- Fresh air knock out
- Multi directional air flow

### Compact design

The panel is a compact (70x70 cm) so it can be installed even in a small room where space is limited.

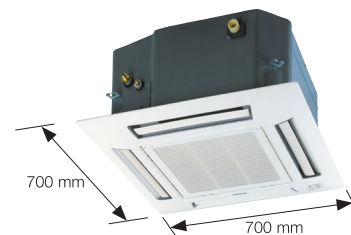

### Lighter and slimmer, easier installation

When only 260mm of indoor body height, it can easily fit in limited spaces and tight spots.  
(Required 288mm from bottom of panel to top of the unit)

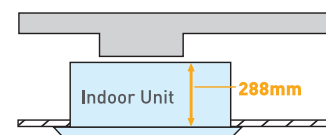

### A drain height of up to 750 mm from the ceiling surface

The internal pump allows the drain pipe to be elevated up to 750mm above the base of the unit.

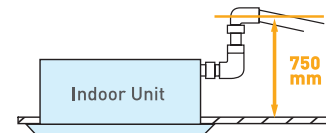

### Anti-Mould Long-Life Air Filter

Anti-mould and anti-bacteria washable filter ensures clean, healthy air.

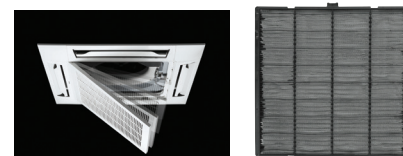



**ECONAVI**  
ECONAVI ready

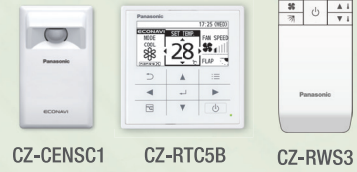

Model Name		S-22MY2E5A	S-28MY2E5A	S-36MY2E5A	S-45MY2E5A	S-56MY2E5A	
Power source		220/230/240 V, 1 phase - 50, 60 Hz					
Cooling capacity	kW	2.2	2.8	3.6	4.5	5.6	
	BTU/h	7,500	9,600	12,300	15,400	19,100	
Heating capacity	kW	2.5	3.2	4.2	5.0	6.3	
	BTU/h	8,500	10,900	14,300	17,100	21,500	
Power input	Cooling kW	0.035	0.035	0.040	0.040	0.045	
	Heating kW	0.030	0.030	0.035	0.035	0.040	
Running amperes	Cooling A	0.30	0.30	0.30	0.30	0.35	
	Heating A	0.25	0.30	0.30	0.30	0.35	
Fan motor	Type	Turbo fan					
	Airflow rate (H/M/L)	m <sup>3</sup> /h	546/492/336	558/504/336	582/522/360	600/558/492	624/588/510
		L/s	152/137/93	155/140/93	162/145/100	167/155/137	173/163/142
	Output	kW	0.04	0.04	0.04	0.04	0.04
Power sound level (H/M/L)		dB	50/46/40	50/46/40	51/47/41	53/49/43	55/52/49
Sound pressure level (H/M/L)		dB(A)	35/31/25	35/31/25	36/32/26	38/34/28	40/37/34
Dimensions*	H x W x D	mm	288 (+31) x 575 (700) x 575 (700)	288 (+31) x 575 (700) x 575 (700)	288 (+31) x 575 (700) x 575 (700)	288 (+31) x 575 (700) x 575 (700)	288 (+31) x 575 (700) x 575 (700)
	Pipe connections	Liquid	mm (inches)	Ø6.35 (Ø1/4)	Ø6.35 (Ø1/4)	Ø6.35 (Ø1/4)	Ø6.35 (Ø1/4)
	Gas	mm (inches)	Ø12.7 (Ø1/2)	Ø12.7 (Ø1/2)	Ø12.7 (Ø1/2)	Ø12.7 (Ø1/2)	Ø12.7 (Ø1/2)
	Drain piping		VP-25	VP-25	VP-25	VP-25	VP-25
Net weight*		kg	18 (+2.4)	18 (+2.4)	18 (+2.4)	18 (+2.4)	18 (+2.4)

GLOBAL REMARKS	Rated conditions:	Cooling	Heating
	Indoor air temperature	27°C DB / 19°C WB	20°C DB
	Outdoor air temperature	35°C DB / 24°C WB	7°C DB / 6°C WB

\* The values in ( ) for external dimensions and Net weight are the values for the optional ceiling panel. Specifications are subject to change without notice.

### Y2 TYPE 4-WAY CASSETTE Dimensions

- 1 Air intake grill
- 2 Air outlet
- 3 Refrigerant piping (liquid pipe) ø6.35 (flared)
- 4 Refrigerant piping (gas pipe) ø12.7 (flared)
- 5 Drain tube connection port VP25 (outer ø32)
- 6 Power supply entry
- 7 Suspension bolt hole (4-11 x 26 slot)
- 8 Fresh air intake duct connection port (ø80)

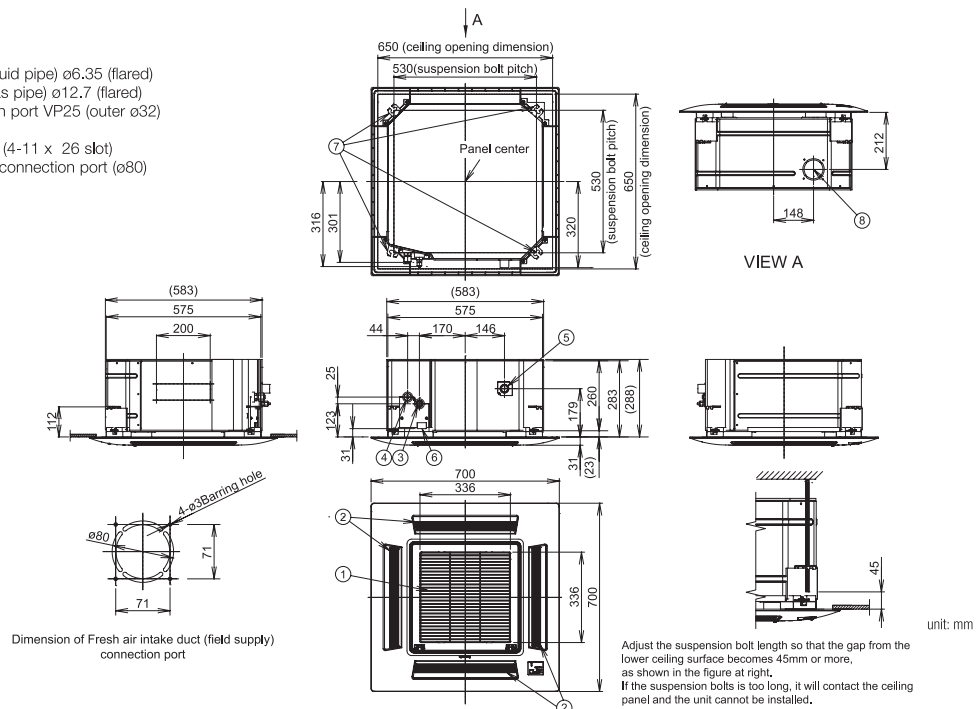

# L1 TYPE 2-Way Cassette

The L1 is very thin, compact and light, allowing flexible install options. A redesigned fan has been used to achieve this size and weight reduction.



Self-diagnosing Function



Automatic Fan Operation



Mild dry



Intelligent Auto Swing



Automatic Restart Function



Auto Swing (Auto Flap Control)



Built-in Drain Pump

## Technical focus

- Airflow and distribution is automatically altered depending on the operational mode of the unit
- Drain up is possible up to 500 mm via the built-in drain pump
- Simple maintenance

### Auto flap control

Airflow and distribution is automatically altered depending on the operational mode (cooling or heating) of the unit.

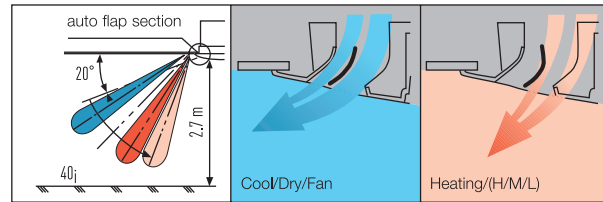

### Drain up is possible up to 500 mm via the built-in drain pump.

Maintenance of the drain pump is possible from both sides, from the left side (piping side) and from the inside of the unit.

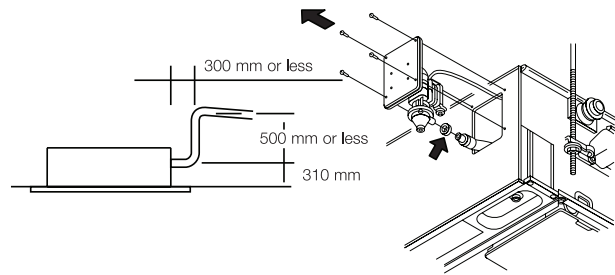

### Simple maintenance

The drain pan is equipped with site wiring and can be removed. The fan case has a split construction, and the fan motor can be removed easily when the lower case is removed.



PANEL



CZ-02KPL2  
Big size panel (for S-73ML1E5)  
CZ-03KPL2



CZ-RTC5B



CZ-RWS3



CZ-RWRL3

Model Name		S-22ML1E5	S-28ML1E5	S-36ML1E5	S-45ML1E5	S-56ML1E5	S-73ML1E5	
Power source		220/230/240V, 1 phase - 50 / 60Hz						
Cooling capacity	kW	2.2	2.8	3.6	4.5	5.6	7.3	
	BTU/h	7,500	9,600	12,000	15,000	19,000	25,000	
Heating capacity	kW	2.5	3.2	4.2	5.0	6.3	8.0	
	BTU/h	8,500	11,000	14,000	17,000	21,000	27,000	
Power input	Cooling kW	0.086/0.090/0.095	0.086/0.092/0.097	0.088/0.093/0.099	0.091/0.097/0.103	0.091/0.097/0.103	0.135/0.145/0.154	
	Heating kW	0.055/0.058/0.062	0.055/0.060/0.064	0.057/0.061/0.066	0.060/0.065/0.070	0.060/0.065/0.070	0.100/0.109/0.117	
Running current	Cooling A	0.45/0.45/0.45	0.44/0.45/0.45	0.44/0.45/0.45	0.45/0.45/0.45	0.45/0.45/0.45	0.64/0.65/0.66	
	Heating A	0.29/0.29/0.30	0.28/0.29/0.30	0.28/0.29/0.30	0.29/0.29/0.30	0.29/0.29/0.30	0.46/0.48/0.49	
Fan	Type	Sirocco fan	Sirocco fan	Sirocco fan	Sirocco fan	Sirocco fan	Sirocco fan	
	Air flow rate (H/M/L)	m <sup>3</sup> /h	480/420/360	540/480/420	580/520/460	660/540/480	660/540/480	1,140/960/840
		L/s	133/117/100	150/133/117	161/144/128	183/150/133	183/150/133	317/267/233
	Motor output	kW	0.03	0.03	0.03	0.03	0.03	0.05
Sound power level (H/M/L)	dB	40/38/35	44/40/37	45/42/39	46/44/40	46/44/40	49/46/44	
Sound pressure level (H/M/L)	dB(A)	30/27/24	33/29/26	34/31/28	35/33/29	35/33/29	38/35/33	
Dimensions *	H x W x D	mm	350+(8)x840 (1,060)x600 (680)	350+(8)x840 (1,060)x600 (680)	350+(8)x840 (1,060)x600 (680)	350+(8)x840 (1,060)x600 (680)	350+(8)x840 (1,060)x600 (680)	350+(8)x1,140 (1,360)x600 (680)
	Liquid	mm (inches)	Ø6.35 (Ø1/4)	Ø6.35 (Ø1/4)	Ø6.35 (Ø1/4)	Ø6.35 (Ø1/4)	Ø6.35 (Ø1/4)	Ø9.52 (Ø3/8)
	Gas	mm (inches)	Ø12.7 (Ø1/2)	Ø12.7 (Ø1/2)	Ø12.7 (Ø1/2)	Ø12.7 (Ø1/2)	Ø12.7 (Ø1/2)	Ø15.88 (Ø5/8)
Pipe connections	Drain piping		VP-25	VP-25	VP-25	VP-25	VP-25	
Net weight *	kg	23 (+5.5)	23 (+5.5)	23 (+5.5)	23 (+5.5)	23 (+5.5)	30 (+9)	

GLOBAL REMARKS	Rated conditions:		
	Cooling	Heating	
	Indoor air temperature	27°C DB / 19°C WB	20°C DB
	Outdoor air temperature	35°C DB / 24°C WB	7°C DB / 6°C WB

\* The values in ( ) for external dimensions and Net weight are the values for the optional ceiling panel. Specifications are subject to change without notice.

### L1 TYPE 2-WAY CASSETTE Dimensions

- 1 Air intake
- 2 Air outlet
- 3 Ceiling opening dimensions
- 4 Suspension fitting (notch: 12 mm)
- 5 Refrigerant piping (liquid pipes)
- 6 Refrigerant piping (gas pipes)
- 7 Drain connection VP25 (outer diameter ø 32)
- 8 Inlet for option cord between power supply and unit
- 9 Drain pan, drain pump inspection lid
- 10 Drain pump inspection lid
- 11 Round flange (field supply) mounting part (fresh air inlet ø 125)
- 12 Discharge duct (field supply) mounting part (installation possible only on the right side)
- 13 Wireless remote controller (option) signal receiver installation part

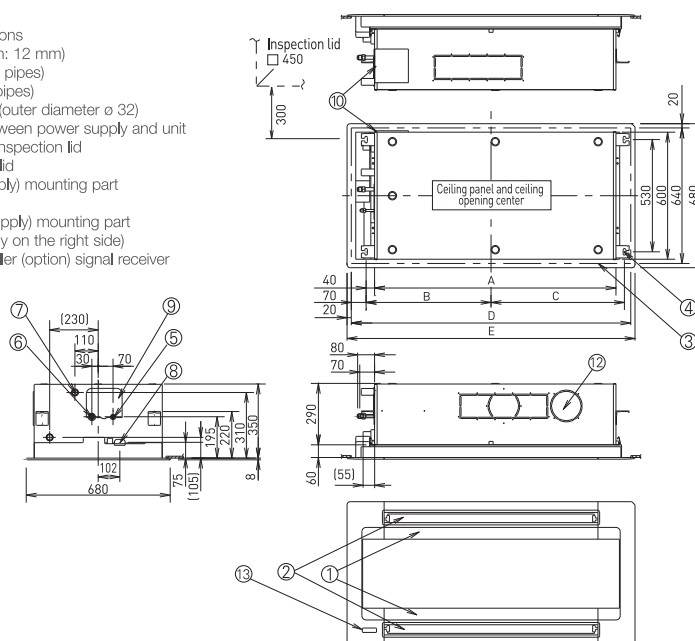

	22-56 type	73 type
A	840	1,140
B	440	590
C	480	630
D	1,020	1,320
E	1,060	1,360
③ Ceiling opening dimensions	1,020x640	1,320x640
⑤ Refrigerant piping (liquid pipes)	ø6.35	ø9.52
⑥ Refrigerant piping (gas pipes)	ø12.7	ø15.88
⑦ Duct connection port (only on the right side)	⑦ x 1 pc.	⑦ x 2 pc.

unit: mm

# D1<sup>TYPE</sup> 1-Way Cassette

## Semi concealed slim cassette



Designed for installation within the ceiling void, the D1 range of slimline 1 way cassettes feature a quiet yet powerful fan that can reach the floor up 4.2 m from ceiling height.



Self-diagnosing  
Function



Automatic  
Fan  
Operation



Mild dry



Intelligent Auto  
Swing



Automatic  
Restart  
Function



Auto Swing  
(Auto Flap Control)



Built-in Drain  
Pump

### Technical focus

- Ultra-Slim profile
- Suitable for standard and high ceilings
- Built-in drain pump provides 590 mm lift from ceiling
- Easy to install and maintain
- Hanging height can be easily adjusted
- Uses a DC fan motor to improve energy-efficiency

### Drain height

A built-in drain pump provides up to 590mm lift from ceiling height for flexible install options.

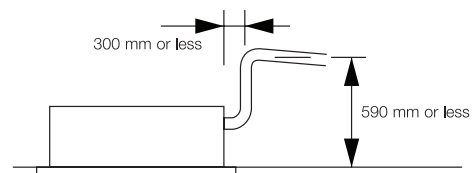

With 3 types of air-blow systems, the units can be used in various ways.

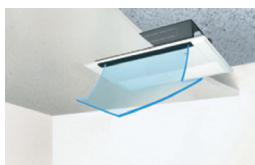

#### (1) One-direction "down-blow" system

Powerful one-direction "down-blow" system reaches the floor even from high ceilings (up to 4.2 m).

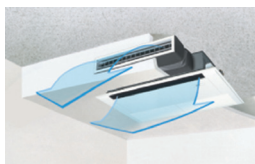

#### (2) Two-direction ceiling-mounted system

"Down-blow" and "front-blow" systems are combined in a ceiling-mounted unit to blow air over a wide area.



#### (3) One-direction ceiling-mounted system

This powerful ceiling-mounted "front-blow" system efficiently air-conditions the space in front of the unit.  
(Additional accessories required)

PANEL



CZ-KPD2



CZ-RTC5B



CZ-RWS3



CZ-RWRD3

Model Name		S-28MD1E5	S-36MD1E5	S-45MD1E5	S-56MD1E5	S-73MD1E5	
Power source		220/230/240 V, 1 phase - 50 / 60 Hz					
Cooling capacity	kW	2.8	3.6	4.5	5.6	7.3	
	BTU/h	9,600	12,000	15,000	19,000	25,000	
Heating capacity	kW	3.2	4.2	5.0	6.3	8.0	
	BTU/h	11,000	14,000	17,000	21,000	27,000	
Power input	Cooling kW	0.050/0.051/0.052	0.050/0.051/0.052	0.050/0.051/0.052	0.058/0.060/0.061	0.086/0.087/0.089	
	Heating kW	0.039/0.040/0.042	0.039/0.040/0.042	0.039/0.040/0.042	0.046/0.048/0.049	0.075/0.076/0.077	
Running current	Cooling A	0.40/0.39/0.39	0.40/0.39/0.39	0.40/0.39/0.39	0.46/0.46/0.46	0.71/0.70/0.69	
	Heating A	0.36/0.35/0.35	0.36/0.35/0.35	0.36/0.35/0.35	0.42/0.41/0.41	0.66/0.65/0.63	
Fan	Type	Sirocco fan	Sirocco fan	Sirocco fan	Sirocco fan	Sirocco fan	
	Air flow rate (H/M/L)	m <sup>3</sup> /h	720/600/540	720/600/540	720/660/600	780/690/600	1,080/900/780
		L/s	200/167/150	200/167/150	200/183/167	217/192/167	300/250/217
	Motor output kW	0.05	0.05	0.05	0.05	0.05	
Sound power level (H/M/L)	dB	47/45/44	47/45/44	47/46/45	49/47/45	56/51/47	
Sound pressure level (H/M/L)	dB(A)	36/34/33	36/34/33	36/35/34	38/36/34	45/40/36	
Dimensions *	H x W x D	mm	200+(20) x 1,000 (1,230) x 710 (800)	200+(20) x 1,000 (1,230) x 710 (800)	200+(20) x 1,000 (1,230) x 710 (800)	200+(20) x 1,000 (1,230) x 710 (800)	
	Liquid	mm (inches)	Ø6.35 (Ø1/4)	Ø6.35 (Ø1/4)	Ø6.35 (Ø1/4)	Ø6.35 (Ø1/4)	
	Gas	mm (inches)	Ø12.7 (Ø1/2)	Ø12.7 (Ø1/2)	Ø12.7 (Ø1/2)	Ø12.7 (Ø1/2)	
Pipe connections	Drain piping		VP-25	VP-25	VP-25	VP-25	
	Net weight *	kg	21 (+5.5)	21 (+5.5)	21 (+5.5)	22 (+5.5)	
GLOBAL REMARKS	Rated conditions:	Cooling	Heating	* The values in ( ) for external dimensions and Net weight are the values for the optional ceiling panel. Specifications are subject to change without notice.			
	Indoor air temperature	27°C DB / 19°C WB	20°C DB				
	Outdoor air temperature	35°C DB / 24°C WB	7°C DB / 6°C WB				

### D1 TYPE 1-WAY CASSETTE Dimensions

- 1 Air intake grille
- 2 Air outlet
- 3 Refrigerant piping (liquid pipes)  
Size 28 to 56: Ø6.35 (flared)  
Size 73: Ø9.52 (flared)
- 4 Refrigerant piping (gas pipes)  
Size 28 to 56: Ø12.7 (flared)  
Size 73: Ø15.88 (flared)
- 5 Drain connection VP25 (outer Ø32)
- 6 Power supply entry
- 7 Discharge duct connection port (for descending ceiling)
- 8 Wireless remote control receiver (option)
- 9 Suspension mounting (4-12 x 30 slot)
- 10 Fresh air intake (Ø100)

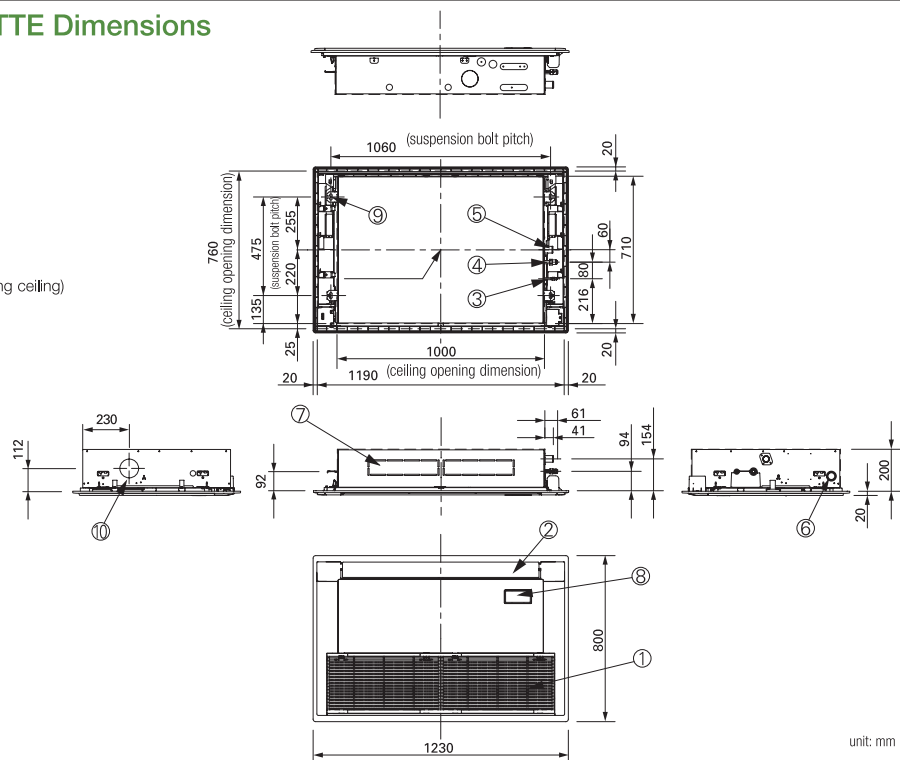

unit: mm



# T2 TYPE Ceiling Mounted

## Ceiling mounted



Providing outstanding energy-saving performance and comfortable, long-distance air flow distribution, it's recommended for stores and schools.



Self-diagnosing Function



Automatic Fan Operation



Mild dry



Intelligent Auto Swing



Automatic Restart Function



Auto Swing (Auto Flap Control)

### Technical focus

- Lower sound levels
- Standardised height and depth for all models
- Long and wide air distribution
- Easy to install and maintain
- Fresh air knockout

### Compact Looking, Stylish, One-Motion Design

With its streamlined, one-motion form, the unit looks slim and compact when installed for a neat appearance in any room. When not operating, the louver closes to provide an elegant look while keeping the unit clean.



### Energy-Saving Technology Delivering Top-Class Efficiency

Optimization of the shape of the casing and fan assures bigger air flow and higher efficiency. Energy-saving performance is top class in the industry.

#### Top Class Energy Saving

#### Large Diagonal Air Flow Fan



DC motor

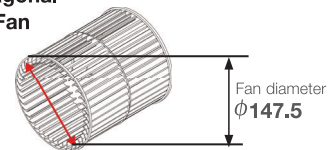

### Comfortable, Long-Distance Air Flow Distribution

The shape of the outlet has been optimized to provide long-distance air flow distribution. Even in deep spaces, air flow reaches every corner for exceptionally comfortable air conditioning.



Ceiling height  
**4.3m\***

Air flow distance  
**13m\***

\*Results are based on specific testing conditions.

High Ceiling Setting <small>*Setting by remote control</small>	Air flow distance		
	4.3m	112	140
	12m	13m	13m

### Multiple Piping Directions For Flexible Installation

The 5-directional drain pipe and 3-directional refrigerant pipe make installation much easier. And the neat fit with walls and ceilings assures more installation flexibility.

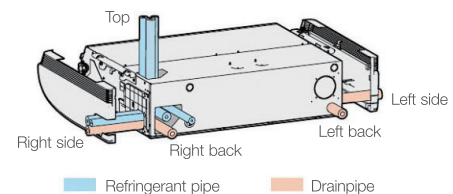



**ECONAVI**  
ECONAVI ready



Model Name		S-36MT2E5A	S-45MT2E5A	S-56MT2E5A	S-73MT2E5A	S-106MT2E5A	S-140MT2E5A	
Power source		220 / 230 / 240 V, 1 phase - 50 / 60 Hz						
Cooling capacity	kW	3.6	4.5	5.6	7.3	10.6	14.0	
	BTU/h	12,300	15,400	19,100	24,900	36,200	47,800	
Heating capacity	kW	4.2	5.0	6.3	8.0	11.4	16.0	
	BTU/h	14,300	17,100	21,500	27,300	38,900	54,600	
Power input	Cooling kW	0.035/0.035/0.035	0.040/0.040/0.040	0.040/0.040/0.040	0.055/0.055/0.055	0.080/0.080/0.080	0.100/0.100/0.100	
	Heating kW	0.035/0.035/0.035	0.040/0.040/0.040	0.040/0.040/0.040	0.055/0.055/0.055	0.080/0.080/0.080	0.100/0.100/0.100	
Running current	Cooling A	0.37/0.36/0.35	0.39/0.38/0.37	0.39/0.38/0.37	0.45/0.44/0.43	0.69/0.67/0.65	0.82/0.79/0.77	
	Heating A	0.37/0.36/0.35	0.39/0.38/0.37	0.39/0.38/0.37	0.45/0.44/0.43	0.69/0.67/0.65	0.82/0.79/0.77	
Fan	Type	Sirocco fan	Sirocco fan	Sirocco fan	Sirocco fan	Sirocco fan	Sirocco fan	
	Air flow rate (H/M/L)	m³/h	840/720/630	900/750/630	900/750/630	1,260/1,080/930	1,800/1,500/1,380	1,920/1,680/1,440
		L/s	233/200/175	250/208/175	250/208/175	350/300/258	500/417/383	533/467/400
	Motor output	kW	0.043	0.043	0.043	0.074	0.111	0.111
Sound power level (H/M/L)	dB	54/50/48	55/51/48	55/51/48	57/53/51	60/55/54	62/58/55	
Sound pressure level (H/M/L)	dB(A)	36/32/30	37/33/30	37/33/30	39/35/33	42/37/36	44/40/37	
Dimensions	H x W x D	mm	235 x 960 x 690	235 x 960 x 690	235 x 960 x 690	235 x 1,275 x 690	235 x 1,590 x 690	235 x 1,590 x 690
	Liquid	mm (inches)	Ø6.35 (Ø1/4)	Ø6.35 (Ø1/4)	Ø6.35 (Ø1/4)	Ø9.52 (Ø3/8)	Ø9.52 (Ø3/8)	Ø9.52 (Ø3/8)
	Gas	mm (inches)	Ø12.7 (Ø1/2)	Ø12.7 (Ø1/2)	Ø12.7 (Ø1/2)	Ø15.88 (Ø5/8)	Ø15.88 (Ø5/8)	Ø15.88 (Ø5/8)
Pipe connections	Drain piping		VP-20	VP-20	VP-20	VP-20	VP-20	
Net weight	kg	27	27	27	33	40	40	

GLOBAL REMARKS	Rated conditions:	Cooling	Heating
	Indoor air temperature	27°C DB / 19°C WB	20°C DB
	Outdoor air temperature	35°C DB / 24°C WB	7°C DB / 6°C WB

Specifications are subject to change without notice.

## T2 TYPE CEILING Dimensions

### SIZE 36-56

### SIZE 73-140

- 1 Drain port VP20 (inside diameter Ø26mm, drain hose supplied)
- 2 Left drain position
- 3 Refrigerant piping (liquid pipes)  
Size 36 to 56: Ø6.35 (flared)  
Size 73 to 140: Ø9.52 (flared)
- 4 Refrigerant piping (gas pipes)  
Size 36 to 56: Ø12.7 (flared)  
Size 73 to 140: Ø15.88 (flared)
- 5 Left side drain hose outlet port (cutout)
- 6 Piping hole on wall surface Ø100mm
- 7 Upper side piping port
- 8 Right side drain hose outlet port (cutout)
- 9 Wireless remote controller receiver installation location

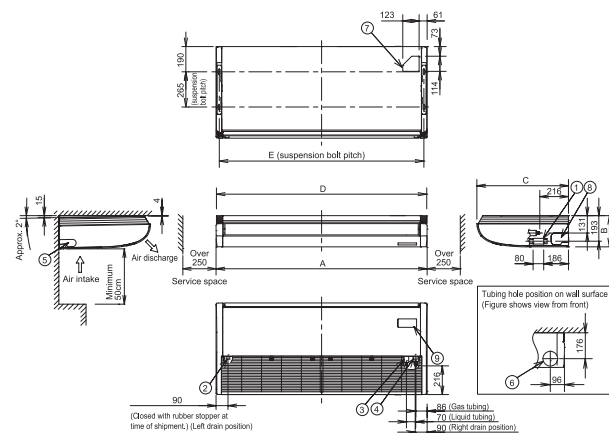
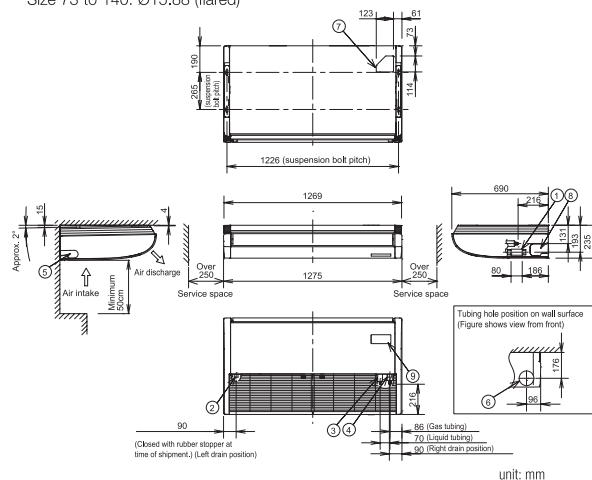

	A	B	C	D	E
106-140 type	1,590	235	690	1,584	1,541
73 type	1,275	235	690	1,269	1,226

unit: mm

unit: mm

# P1 TYPE Floor Standing

The compact floor standing P1 units are the ideal solution for providing perimeter air conditioning. A standard wired controller can be incorporated into the body of the unit.



Self-diagnosing Function



Automatic Fan Operation



Mild dry



Automatic Restart Function

## Technical focus

- Pipes can be connected to either side of the unit from the bottom or rear
- Easy to install
- Front panel opens fully for easy maintenance
- Removable air discharge grille gives flexible air flow

## Effective perimeter air conditioning

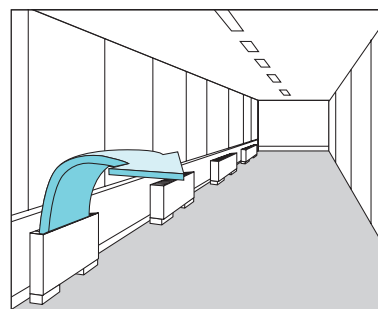

## A standard wired remote control can be installed in the body

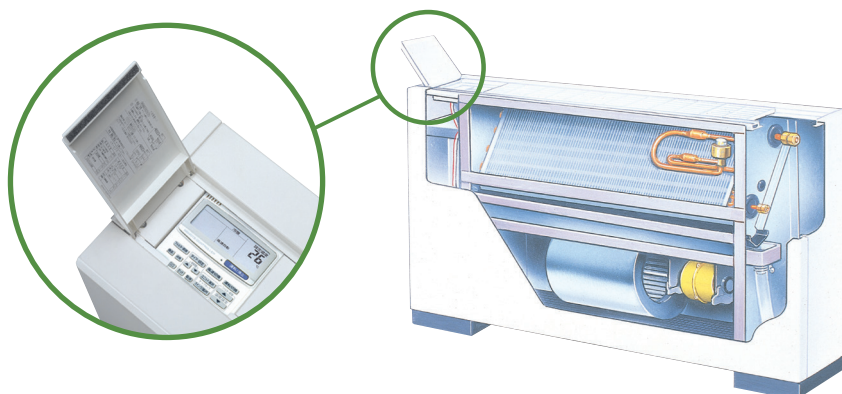





CZ-RTC5B



CZ-RWS3



CZ-RWRC3

Model Name		S-22MP1E5	S-28MP1E5	S-36MP1E5	S-45MP1E5	S-56MP1E5	S-71MP1E5	
Power source		220/230/240 V, 1 phase - 50 / 60 Hz						
Cooling capacity	kW	2.2	2.8	3.6	4.5	5.6	7.1	
	BTU/h	7,500	9,600	12,000	15,000	19,000	24,000	
Heating capacity	kW	2.5	3.2	4.2	5.0	6.3	8.0	
	BTU/h	8,500	11,000	14,000	17,000	21,000	27,000	
Power input	Cooling kW	0.051/0.056/0.061	0.051/0.056/0.061	0.079/0.085/0.091	0.116/0.126/0.136	0.116/0.126/0.136	0.150/0.160/0.170	
	Heating kW	0.036/0.040/0.045	0.036/0.040/0.045	0.064/0.070/0.076	0.079/0.091/0.101	0.079/0.091/0.101	0.110/0.120/0.130	
Running current	Cooling A	0.24/0.25/0.26	0.24/0.25/0.26	0.37/0.38/0.39	0.54/0.56/0.58	0.54/0.56/0.58	0.70/0.72/0.73	
	Heating A	0.17/0.18/0.19	0.17/0.18/0.19	0.30/0.31/0.32	0.37/0.41/0.43	0.37/0.41/0.43	0.52/0.54/0.56	
Fan	Type	Sirocco fan	Sirocco fan	Sirocco fan	Sirocco fan	Sirocco fan	Sirocco fan	
	Air flow rate (H/M/L)	m³/h	420/360/300	420/360/300	540/420/360	720/540/480	900/780/660	1,020/840/720
		L/s	117/100/83	117/100/83	150/117/100	200/150/133	250/217/183	283/233/200
	Motor output	kW	0.01	0.01	0.02	0.02	0.03	0.06
Sound power level (H/M/L)	dB	44/41/39	44/41/39	50/46/40	49/46/42	50/47/42	52/49/46	
Sound pressure level (H/M/L)	dB(A)	33/30/28	33/30/28	39/35/29	38/35/31	39/36/31	41/38/35	
Dimensions	H x W x D	mm	615 x 1,065 x 230	615 x 1,065 x 230	615 x 1,065 x 230	615 x 1,380 x 230	615 x 1,380 x 230	
	Liquid	mm (inches)	Ø6.35 (Ø1/4)	Ø6.35 (Ø1/4)	Ø6.35 (Ø1/4)	Ø6.35 (Ø1/4)	Ø6.35 (Ø1/4)	
	Gas	mm (inches)	Ø12.7 (Ø1/2)	Ø12.7 (Ø1/2)	Ø12.7 (Ø1/2)	Ø12.7 (Ø1/2)	Ø12.7 (Ø1/2)	
Pipe connections	Drain piping		VP-20	VP-20	VP-20	VP-20	VP-20	
Net weight	kg	29	29	29	39	39	39	

GLOBAL REMARKS	Rated conditions:	
	Cooling	Heating
	Indoor air temperature	27°C DB / 19°C WB
Outdoor air temperature	35°C DB / 24°C WB	7°C DB / 6°C WB

Specifications are subject to change without notice.

## P1 TYPE FLOOR STANDING Dimensions

- 1 4 x Ø12 holes (for floor fixing)
- 2 Power supply outlet
- 3 Air filter
- 4 Refrigerant piping (liquid pipes)
- 5 Refrigerant piping (gas pipes)
- 6 Level adjustment bolt
- 7 Drain outlet VP20 (with vinyl hose)
- 8 Refrigerant piping connection port (bottom or rear)
- 9 Operation switch (remote controller RCS-SH80AG) mounting part
- 10 Electric equipment box
- 11 Accessory copper pipe for gas pipe connection

Indoor unit	A	B	C	Liquid pipes	Gas pipes
22 to 36 type	1,065	665	632	Ø6.35	Ø12.7
45 type					
56 type	1,380	980	947	Ø9.52	Ø15.88
71 type					

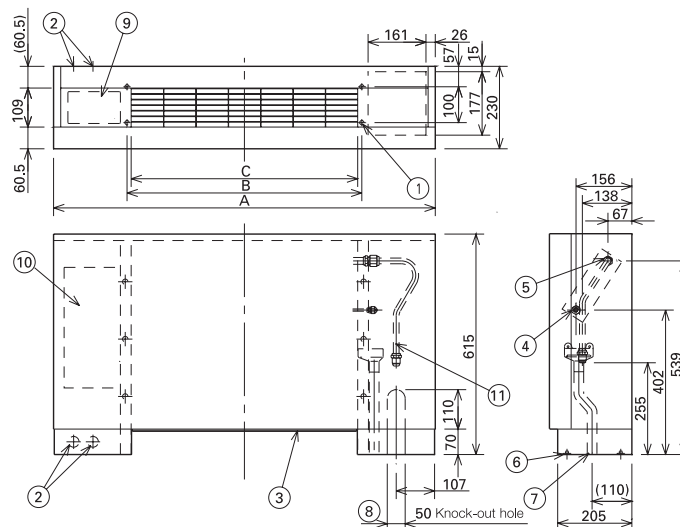

unit: mm

# R1 TYPE Concealed Floor Standing

At just 229 mm deep, the R1 unit can be easily concealed in perimeter areas to provide powerful and effective air conditioning.



Self-diagnosing  
Function



Automatic  
Fan  
Operation



Mild dry



Automatic  
Restart  
Function

## Technical focus

- Chassis unit for discrete customisable installation
- Complete with removable filters
- Pipes can be connected to the unit either from the bottom or rear
- Easy to install

## Perimeter air conditioning with high interior quality

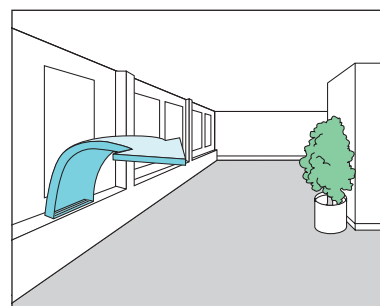

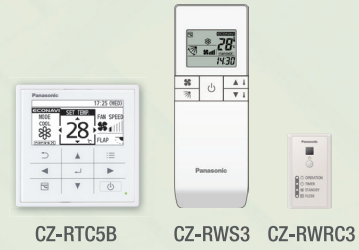
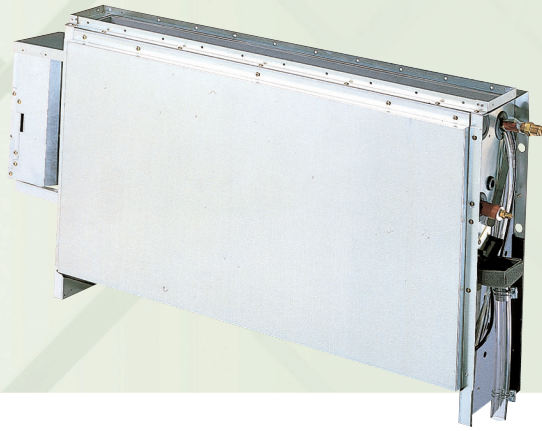

Model Name		S-22MR1E5	S-28MR1E5	S-36MR1E5	S-45MR1E5	S-56MR1E5	S-71MR1E5	
Power source		220/230/240 V, 1 phase - 50, 60 Hz						
Cooling capacity	kW	2.2	2.8	3.6	4.5	5.6	7.1	
	BTU/h	7,500	9,600	12,000	15,000	19,000	24,000	
Heating capacity	kW	2.5	3.2	4.2	5.0	6.3	8.0	
	BTU/h	8,500	11,000	14,000	17,000	21,000	27,000	
Power input	Cooling kW	0.051/0.056/0.061	0.051/0.056/0.061	0.079/0.085/0.091	0.116/0.126/0.136	0.116/0.126/0.136	0.150/0.160/0.170	
	Heating kW	0.036/0.040/0.045	0.036/0.040/0.045	0.064/0.070/0.076	0.079/0.091/0.101	0.079/0.091/0.101	0.110/0.120/0.130	
Running current	Cooling A	0.24/0.25/0.26	0.24/0.25/0.26	0.37/0.38/0.39	0.54/0.56/0.58	0.54/0.56/0.58	0.70/0.72/0.73	
	Heating A	0.17/0.18/0.19	0.17/0.18/0.19	0.30/0.31/0.32	0.37/0.41/0.43	0.37/0.41/0.43	0.52/0.54/0.56	
Fan	Type	Sirocco fan	Sirocco fan	Sirocco fan	Sirocco fan	Sirocco fan	Sirocco fan	
	Air flow rate (H/M/L)	m³/h	420/360/300	420/360/300	540/420/360	720/540/480	900/780/660	1,020/840/720
		L/s	117/100/183	117/100/183	150/117/100	200/150/133	250/217/183	283/233/200
	Motor output	kW	0.01	0.01	0.02	0.02	0.03	0.06
Sound power level (H/M/L)	dB	44/41/39	44/41/39	50/46/40	49/46/42	49/46/42	52/49/46	
Sound pressure level (H/M/L)	dB(A)	33/30/28	33/30/28	39/35/29	38/35/31	39/36/31	41/38/35	
Dimensions	H x W x D	mm	616 x 904 x 229	616 x 904 x 229	616 x 904 x 229	616 x 1,219 x 229	616 x 1,219 x 229	616 x 1,219 x 229
	Liquid	mm (inches)	Ø6.35 (Ø1/4)	Ø6.35 (Ø1/4)	Ø6.35 (Ø1/4)	Ø6.35 (Ø1/4)	Ø6.35 (Ø1/4)	Ø9.52 (Ø3/8)
	Gas 410 A	mm (inches)	Ø12.7 (Ø1/2)	Ø12.7 (Ø1/2)	Ø12.7 (Ø1/2)	Ø12.7 (Ø1/2)	Ø12.7 (Ø1/2)	Ø15.88 (Ø5/8)
Pipe connections	Drain piping		VP-20	VP-20	VP-20	VP-20	VP-20	VP-20
Net weight	kg	21	21	21	28	28	28	

GLOBAL REMARKS	Rated conditions:	
	Cooling	Heating
	Indoor air temperature	27°C DB / 19°C WB
Outdoor air temperature	35°C DB / 24°C WB	7°C DB / 6°C WB

Specifications are subject to change without notice.

### R1 TYPE CONCEALED FLOOR STANDING Dimensions

- 1 4 x Ø12 holes (for floor fixing)
- 2 Electric equipment box
- 3 Power supply outlet
- 4 Air filter
- 5 Discharge duct connection flange
- 6 Refrigerant connection outlet (liquid pipes)
- 7 Refrigerant connection outlet (gas pipes)
- 8 Drain filter
- 9 Drain pan
- 10 Level adjustment bolt
- 11 Drain outlet VP20 (with vinyl hose)

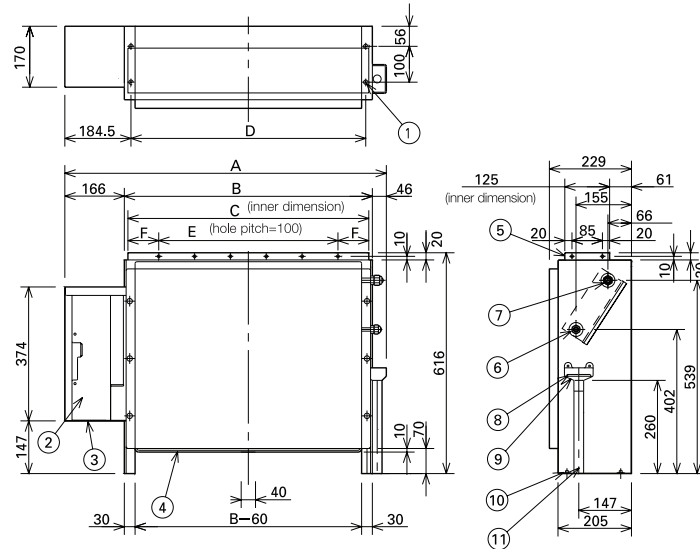

unit: mm

Indoor unit	A	B	C	D	E	F	Liquid pipes	Gas pipes
22 to 36 type	904	692	672	665	500	86	Ø6.35	Ø12.7
45 type								
56 type	1,219	1,007	1,002	980	900	51	Ø9.52	Ø15.88
71 type								



## Remark for High Static Ducted Series





E2 type  
**High Static Ducted**

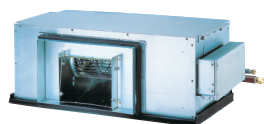

E2 type  
**Energy Saving High-Fresh Air Ducted**





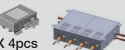

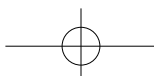
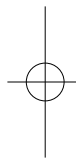
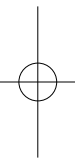
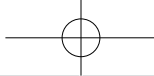
H1 type  
**High-Fresh Air Ducted**

Model	Operation	Rap valve kit <b>CZ-P160RVK2</b> 	3-way control PCB <b>CZ-CAPE2</b> 	3-way valve kit <b>CZ-P160HR3</b> 	3-way valve kit multiple connection port type 4 port <b>CZ-P4160HR3 (160 type)</b>  X 4pcs	Distribution Joint kit <2pipes> <b>CZ-P160BK2</b> for 22.4kW unit or less <b>CZ-P680BK2</b> for more than 22.4kW	Distribution Joint kit <3pipes> <b>CZ-P224BH2</b> for 22.4kW unit <b>CZ-P680BH2</b> for 28.0kW unit
E2 Type <b>High Static Ducted</b>	Cooling Only	-	-	-	-	-	-
	Cool or Heat	-	-	-	-	-	-
	Heat Recovery	-	2pcs	2pcs	use 2ports	1pc	1pc
E2 Type <b>Energy Saving High-Fresh Air Ducted</b>	Cooling Only	-	-	-	-	-	-
	Cool or Heat	2pcs	2pcs	-	-	2pcs	-
	Heat Recovery	-	2pcs	2pcs	use 2ports	1pc	1pc
H1 Type <b>High-Fresh Air Ducted</b>	Cooling Only	-	-	-	-	-	-
	Cool or Heat	2pcs	-	-	-	2pcs	-
	Heat Recovery	-	-	2pcs	use 2ports	1pc	1pc



# FSV Controllers

A wide variety of control options to meet the requirements of different applications.

OPERATION SYSTEM	INDIVIDUAL CONTROL SYSTEMS				TIMER OPERATION
Requirements	High-spec operation	Normal operation	Operation from anywhere in the room	Quick and easy operation	Daily and weekly program
External appearance					
Type, model name	High-spec Wired Remote Controller CZ-RTC5B	Timer Remote Controller (Wired) CZ-RTC4	Wireless Remote Controller Controller: CZ-RWS3 Receiver: CZ-RWRU3 CZ-RWRL3 CZ-RWRD3 CZ-RWRT3 CZ-RWRC3	Simplified Remote Controller CZ-RE2C2	Schedule Timer CZ-ESWC2
Built-in thermostat	●	●	—	●	—
ECONAVI ON/OFF control	●	●	●	—	—
Number of indoor units which can be controlled	1 group, 8 units	1 group, 8 units	CZ-RWRT3 CZ-RWRC3	1 group, 8 units	64 groups, max. 64 units
Use limitations	· Up to 2 controllers can be connected per group (When using ECONAVI sensor, only one remote controller is possible to connect at indoor unit)	· Up to 2 controllers can be connected per group (When using ECONAVI sensor, only one remote controller is possible to connect at indoor unit)	· Up to 2 controllers can be connected per group.	· Up to 2 controllers can be connected per group.	· Required power supply from the system controller · When there is no system controller, connection is possible to the T10 terminal of an indoor unit.
Function ON/OFF	●	●	●	●	—
Mode setting	●	●	●	●	—
Fan speed setting	●	●	●	●	—
Temperature setting	●	●	●	●	—
Air flow direction	●	●	●	●	—
Permit/Prohibit switching	—	—	—	—	—
Weekly program	●	●	—	—	●

All specifications are subject to change without notice.



**ECONAVI**  
**ECONAVI Sensor**  
 CZ-CENSC1



Utilises ECONAVI Sensor and Control Program technologies to detect where energy is normally wasted and self-adjusts cooling power to reduce energy waste.

- Activity detection
- Absence detection

CENTRALISED CONTROL SYSTEMS					
Operation with various functions from a central location	Only ON/OFF operation from a central location	Simplified load distribution ratio (LDR) for each tenant	BMS System PC Base	Connection with 3rd Party Controller	
			10.4 in. touch screen panel color LCD	<b>P-AIMS Software</b> Up to 1024 units	<b>Seri-Para I/O unit for outdoor unit</b> CZ-CAPDC2
System Controller	ON/OFF Controller	Intelligent Controller		 CZ-CSWKC2	<b>Interface Adaptor</b> CZ-CAPC3
CZ-64ESMC3	CZ-ANC3	CZ-256ESMC3 (CZ-CFUNC2)		<b>Optional software</b>	<b>Seri-Para I/O unit for each indoor unit</b> CZ-CAPBC2
—	—	—			<b>Communication Adaptor</b> CZ-CFUNC2
64 groups, max. 64 units	16 groups, max. 64 units	64 units x 16 systems, max. 256 units		CZ-CSWAC2 for Load distribution CZ-CSWWC2 for Web application CZ-CSWGC2 for Object layout display CZ-CSWBC2 for BACnet software interface *PC required (field supply)	<b>LonWorks Interface</b> CZ-CLNC2
<ul style="list-style-type: none"> <li>Up to 10 controllers, can be connected to one system.</li> <li>Main unit/sub unit (1 main unit + 1 sub unit) connection is possible.</li> <li>Use without remote controller is possible.</li> </ul>	<ul style="list-style-type: none"> <li>Up to 8 controllers (4 main units + 4 sub units) can be connected to one system.</li> <li>Use without remote controller is impossible.</li> </ul>	<ul style="list-style-type: none"> <li>A communication adaptor (CZ-CFUNC2) must be installed for three or more links.</li> </ul>			
●	●	●			
●	—	●			
●	—	●			
●	—	●			
●	—	●			
●	●	●			
●	—	●			

# Individual Control Systems

Control contents	Part name, model No.	Quantity
<p><b>Standard Control</b></p> <ul style="list-style-type: none"> <li>Control of the various operations of the indoor unit by wired or wireless remote controller.</li> <li>Cooling or heating mode of the outdoor unit is decided by the first priority of the remote controller.</li> <li>Switching between remote controller sensor and body sensor is possible.</li> </ul>	<p>Timer remote controller CZ-RTC4 / CZ-RTC5B Simplified remote controller CZ-RE2C2 Wireless remote controller + Receiver CZ-RWS3 (Wall Mounted/ Mini Cassette) CZ-RWS3 + CZ-RWRU3 (4-WAY Cassette) CZ-RWS3 + CZ-RWRL3 (2-WAY Cassette) CZ-RWS3 + CZ-RWRD3 (1-WAY Cassette) CZ-RWS3 + CZ-RWRT3 (Ceiling Mounted) CZ-RWS3 + CZ-RWRC3 (All split type)</p>	1 unit each
<p><b>(1) Group control</b></p> <ul style="list-style-type: none"> <li>Batch remote control on all indoor units.</li> <li>Operation of all indoor units in the same mode.</li> <li>Up to 8 units can be connected.</li> <li>The sensor is the body sensor, and thermostat ON/OFF setting in regard to the temperature set by the remote controller is possible for each indoor unit.</li> </ul>	<p>Timer remote controller CZ-RTC4 / CZ-RTC5B Simplified remote controller CZ-RE2C2 Wireless remote controller + Receiver CZ-RWS3 (Wall Mounted/ Mini Cassette) CZ-RWS3 + CZ-RWRU3 (4-WAY Cassette) CZ-RWS3 + CZ-RWRL3 (2-WAY Cassette) CZ-RWS3 + CZ-RWRD3 (1-WAY Cassette) CZ-RWS3 + CZ-RWRT3 (Ceiling Mounted) CZ-RWS3 + CZ-RWRC3 (All split type)</p>	1 unit
<p><b>(2) Main/sub remote control</b></p> <ul style="list-style-type: none"> <li>Max 2 remote controllers per indoor unit. (Main remote controller can be connected)</li> <li>The button pressed last has priority.</li> <li>Timer setting is possible even with the sub remote controller. (When using ECONAVI sensor, only one remote controller is possible to connect at indoor unit)</li> </ul>	<p>Timer remote controller CZ-RTC4 / CZ-RTC5B Simplified remote controller CZ-RE2C2 Wireless remote controller + Receiver CZ-RWS3 (Wall Mounted/ Mini Cassette) CZ-RWS3 + CZ-RWRU3 (4-WAY Cassette) CZ-RWS3 + CZ-RWRL3 (2-WAY Cassette) CZ-RWS3 + CZ-RWRD3 (1-WAY Cassette) CZ-RWS3 + CZ-RWRT3 (Ceiling Mounted) CZ-RWS3 + CZ-RWRC3 (All split type)</p>	As required

## SYSTEM EXAMPLE FSV

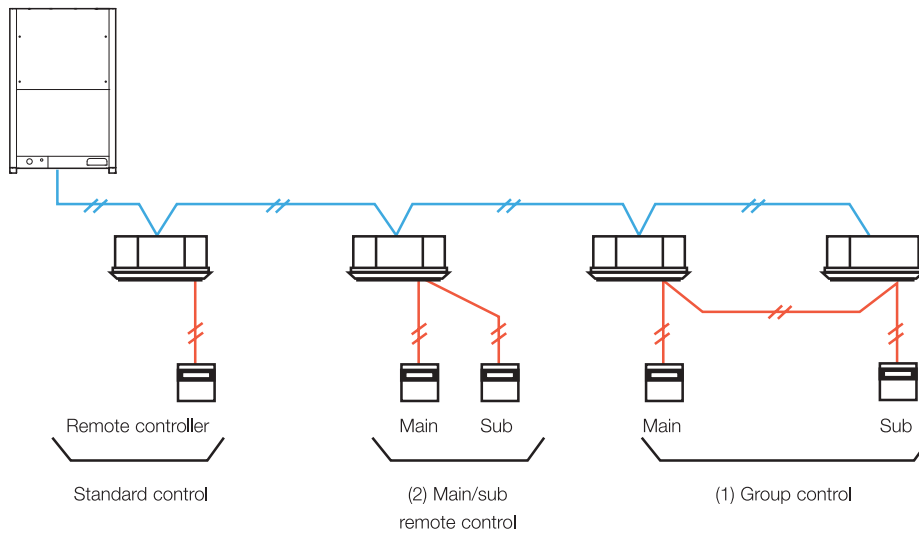

## High-spec wired remote controller (CZ-RTC5B)

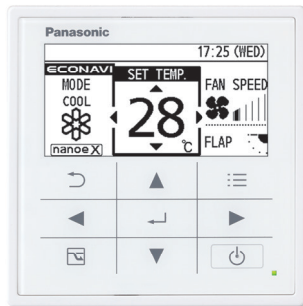

Dimensions  
H 120 x W 120 x D 16 mm

### Energy Saving

- ECONAVI on/ off\*
- Temperature Auto Return
- Temperature Setting Range
- Auto Shutoff
- Schedule peak cut
- Repeat off timer

### Basic Operation

- Individual Louver Control (Lock individual flap only for 4-way cassette U1 type)
- ON/ OFF timer
- Weekly Timer
- Filter information\*
- Outing function
- Quiet operation mode\*
- Energy saving
- Initial settings
- Ventilation

### Maintenance Function

- Outdoor unit error data
- Service Contact address
- RC setting mode
- Test Run
- Sensor Information
- Service check
- Simple/ Detailed Settings
- Auto address

\* Depending on the model, some menus cannot be used.

## Timer remote controller (CZ-RTC4)

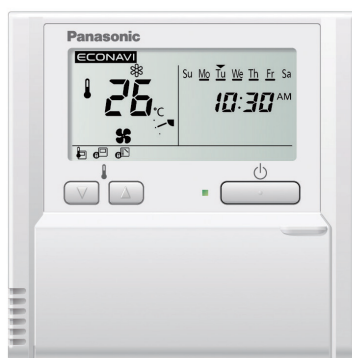

Dimensions  
H 120 x W 120 x D 20 mm

### Basic remote controller ON/OFF

- Operation mode changeover (Cooling, Heating, Dry, Auto, Fan).
- Temperature setting (Cooling/Dry: 18-30 deg Heating: 16-30 deg).
- Fan speed setting H/ M/ L and Auto.
- Air flow direction adjustment.
- ECONAVI on/ off\*

### Time Function 24 hours real time clock

- Day of the week indicator.

### Weekly Programme Function

- A maximum of 6 settings/day and 42 settings/week can be programmed.

### Outing Function

- This function can prevent the room temperature from dropping or rising when the occupants are out for a long time.

### Sleeping Function

- This function controls the room temperature for comfortable sleeping.

### Max. 8 indoor units can be controlled from one remote controller

### Remote control by main remote controller and sub controller is possible

Max. 2 remote controllers (main remote controller and sub controller) can be installed for one indoor unit.

\* Depending on the model, some menus cannot be used.



Wireless remote controller

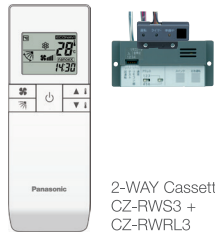

2-WAY Cassette  
CZ-RWS3 +  
CZ-RWRL3



4-WAY Cassette  
CZ-RWS3 +  
CZ-RWRU3



Ceiling Mounted  
CZ-RWS3 +  
CZ-RWRT3

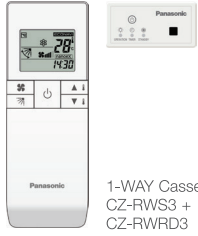

1-WAY Cassette  
CZ-RWS3 +  
CZ-RWRD3



For all indoor units  
CZ-RWS3 +  
CZ-RWRC3



Wall /  
Mini Cassette  
CZ-RWS3

Remote control by main remote controller and sub controller is possible

- Max. 2 remote controllers (main remote controller and sub controller) can be installed for one indoor unit.

When CZ-RWS3 is used, wireless control becomes possible for all indoor units

- When a separate receiver is set up in a different room, control from that room also becomes possible.
- Automatic operation by means of the emergency operation button is possible even when the remote controller has been lost or the batteries have been exhausted.

In addition, there are other functions such as temperature setting, operation switching, airflow direction/fan speed setting, etc

Ventilation independent operation is possible

When commercial ventilation fans or heat-exchange ventilation fans have been installed, they can be operated with this remote control (interlocked operation with the indoor unit or independent ventilation ON/OFF).

Simplified remote controller (CZ-RE2C2)



Dimensions  
H 120 x W 70 x D 17 mm

A remote controller with simple functions and basic operation

- Suitable for open rooms or hotels where detailed functions are not required.
- ON/OFF, operation mode switching, temperature setting, airflow velocity switching, airflow direction setting, alarm display, and remote controller self-diagnosis can be performed.
- Batch group control for up to 8 indoor units.
- Remote control by main remote controller and sub controller is possible with a simplified remote controller or a wired remote controller (up to two units).
- Built-in temperature sensor

# Timer Operation

## Schedule timer (CZ-ESWC2)

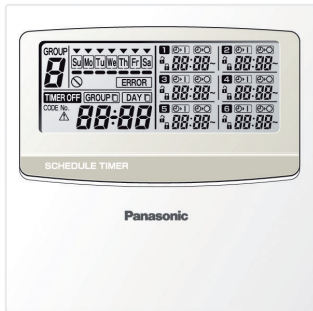

Dimensions  
H 120 x W 120 x D 16 mm

- A function for pausing the timer in case of national holidays has been added, and timer operation also can be stopped for a long time

- By setting holidays or operation stop within one week, the timer can be paused just for that week.
- All timer settings can be stopped with the timer "ON/OFF effective" button. (Return to timer operation is made by pressing the button again.)

Up to 64 groups (max 64 indoor units) can be controlled divided into 8 timer groups

- Six program operations (Operation/Stop/ Local permission/ Local prohibition) per day can be set in a program for one week

- Only operation or stop, remote controller local permission or remote controller local prohibition, and their respective combinations are possible. (Operation + local permission, stop + local prohibition, only local permission, etc.)
- Local prohibition and the combination of the three items of temperature setting, mode change, and operation/stop can be set at the time of installation.

The power supply for the schedule timer is taken from one of the following.

1. Control circuit board (T10) of a nearby indoor unit (power supply wiring length: within 200m from the indoor unit).
2. System controller (power supply wiring length: within 100 m from the indoor unit).

When the power supply for the schedule timer is taken from the control circuit board of the indoor unit, that indoor unit cannot be used with other control devices using the T10 terminal.

As operation mode and temperature settings are not possible with the schedule timer, it must be used together with a remote controller, a system controller, an intelligent controller, etc. Also, as it does not have an address setting function, the control function of a system controller etc. must be used for address setting.

### Connection example 1 (POWER SUPPLY FROM THE INDOOR UNIT)

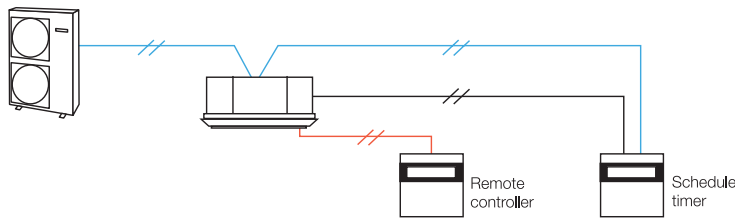

### Connection example 2 (POWER SUPPLY FROM THE SYSTEM CONTROLLER AND ON/OFF CONTROLLER)

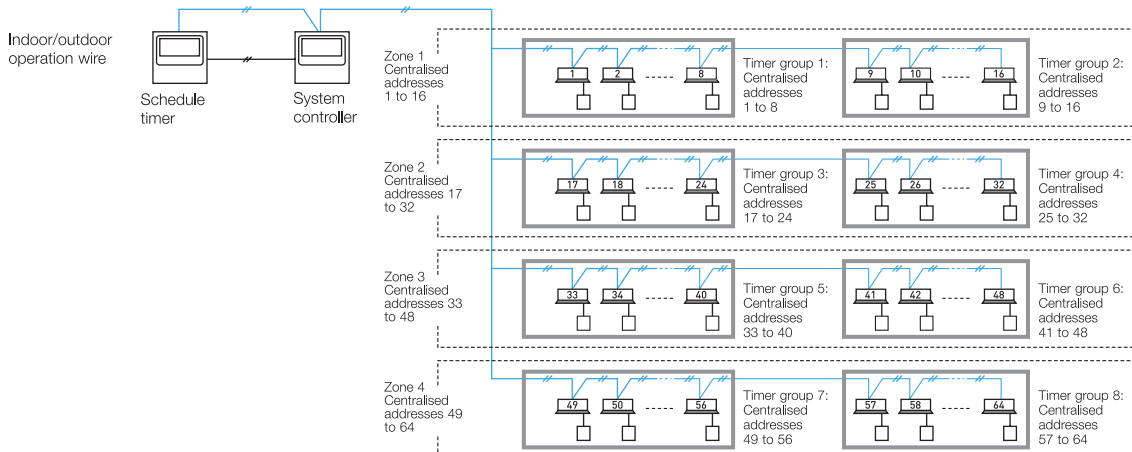

# Centralised Control Systems

## System controller (CZ-64ESMC3)

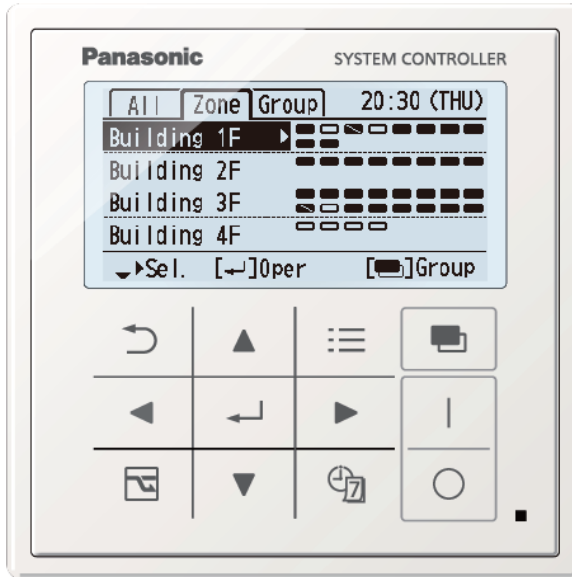

Dimensions  
H 120 x W 120 x D 16 + 52  
(embedding dimension mm)

Power supply: AC 100 to 240 V  
I/O part:  
Remote input part (effective voltage:DC24V) All operation, All stop, Demand 1, Demand 2  
Remote output part (non voltage contact) Operation, Alarm (external power supply within DC 30V, max 0.5A)  
Total wiring length : 1 km

Individual control is possible for max 64 groups, 64 indoor units.

- Control of 64 indoor units divided into 4 zones. (One zone can have up to 16 groups, and one group can have up to 8 units.)
- Control is possible for ON/OFF, operation mode, fan speed, air flow direction, operation monitoring, alarm monitoring, ventilation, remote controller local operation prohibition, etc.

### Prohibition setting for Remote controller operation

Setting mode	ON/OFF	Mode	Temperature	Fan speed	Flap
Permit	●	●	●	●	●
Prohibit 1	—	●	●	●	●
Prohibit 2	—	—	—	●	●
Prohibit 3	●	—	—	●	●
Prohibit 4	●	—	●	●	●

In case of joint use with a wireless remote controller, there are limitations for the control mode. Please use only with setting "Permit" and "Prohibit1 (prohibition for ON/OFF)".

\*Contents for Prohibit 1~4 can be modified.

□ : Operation from the remote controller is possible.

— : Operation from the remote controller is prohibited.

- **Joint use with a remote controller, an intelligent controller, etc. is possible**

(The maximum number of connectable system controllers is 10, including other central controllers on the same circuit.)

(In case of joint use with a wireless remote controller, there are limitations for the control mode. Please use only with setting "Permit" and "Prohibit1 (prohibition for ON/OFF)".)

- **Control of systems without a remote controller and of main/sub systems (a total of up to 2 units) is possible**

- **Weekly timer function**

- 8 programs per day (with ON/OFF/Mode/Temperature/Central control setting items) for 1 week (7days) can be set.
- Special holiday setting can ignore the timer operation temporary by keeping original timer setting. (Special holiday setting can be removed by same setting display.)

- **5 types of Energy saving function**

Set temperature automatic return / Set temperature range limitation / Off remind / Off timer operation / Demand control timer

• A control mode corresponding to the use condition can be selected from 10 patterns

A : Operation mode: Central control mode or remote control mode can be selected

Central control mode: The system controller is used as centralised control device. (Setting from a remote controller can be prohibited by prohibiting local operation from the system controller.)

Remote control mode: The system controller is used as a remote controller. (Setting from the system controller can be prohibited by prohibiting local operation from another central control unit.)

B : Controlled unit number mode: All mode or zone 1, 2, 3, 4 mode can be selected

All mode: All, zone, or group unit can be selected.

Zone 1, 2, 3, 4 mode: Setting is possible only for the indoor units of zone 1, 2, 3, or 4.

Connection example		A Operation mode	
		Central control mode	Remote control mode
B Controlled unit number mode	All mode	All central control Example 1	All remote control
	Zone 1 mode	Zone 1 central control Example 2	Zone 1 remote control
	Zone 2 mode	Zone 2 central control Example 3	Zone 2 remote control Example 3
	Zone 3 mode	Zone 3 central control Example 4	Zone 3 remote control
	Zone 4 mode	Zone 4 central control Example 5	Zone 4 remote control Example 5

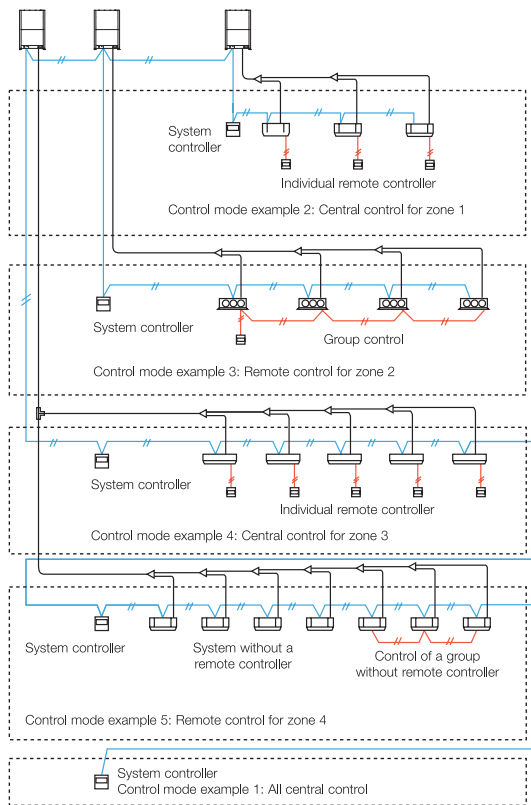

ON/OFF controller (CZ-ANC3)

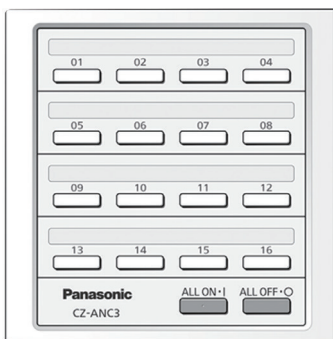

Dimensions  
H 121 x W 122 x D 14 + 52  
(embedding dimension mm)

Power supply: AC 100 to 240 V  
I/O part:  
Remote input (effective voltage: within DC 24 V): All ON/OFF  
Remote output (allowable voltage: within DC 30 V): All ON, All alarm

- 16 groups of indoor units can be controlled.
- Collective control and individual group (unit) control can also be performed.
- Up to 8 ON/OFF controller (4 main, 4 sub) can be installed in one link system.
- The operation status can be determined immediately.



Intelligent controller (CZ-256ESMC3)

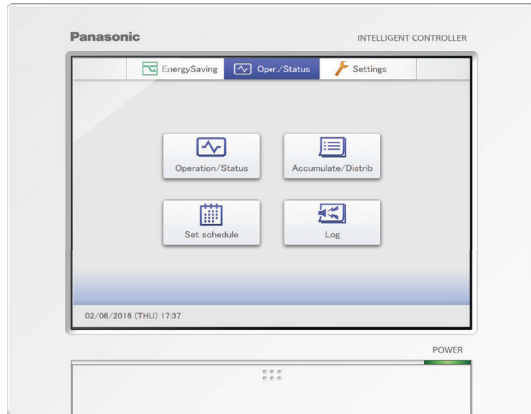

Touch panel

Dimensions  
 H 240 x W 280 x D 85 mm  
 Power supply AC 100 to 240 V (50/60 Hz)  
 LCD: 10.4 in. TFT, XGA(1024 x 768), LED backlight

Product Features

- 10.4 in., Large, easy-to-use color LCD
  - With smartphone like operations, such as swiping and flicking
- Enhanced energy-saving control functions
  - Packed with demand functions
  - Set temperature auto return settings, Auto shutoff, Set temperature range limit settings
- Energy Visualization
  - Displays electricity & gas usage distribution
  - Supports energy-saving plans with graph display function

New Features

- Max 256 indoor unit [4 links x 64 units] can be controlled. In case of three or more systems [more than 128 units], a communication adaptor CZ-CFUNC2 must be installed for three or more links.
- Operation is possible as batch, in zone units, and in group units.
- ON/OFF, operation mode setting, temperature setting, for fan speed setting, air flow direction setting (when used without a remote controller) and remote controller local operation prohibition [prohibition 1,2,3,4] can be done
- Graph display [trends, comparisons]
- ECONAVI ON/OFF

- Outdoor unit quiet operation ON/OFF
- Energy-saving Functions
- Event control [such as equipment linkage]
- Limitation contents for prohibited operation

Prohibition means limitation of the operation contents from the remote controller. It is also possible to change the prohibition items.

Limitation contents (Limitations can be user defined)

- Individual There is no limitation for the operation of the remote controller. However, the contents will be changed to the contents of the controller operated last. (Last-pressed priority.)
- Prohibition 1 The remote controller cannot be used for ON/OFF. (All other operations are possible from the remote controller.)
- Prohibition 2 The remote controller cannot be used for ON/OFF, operation mode change and temperature setting. (All other operations are possible from the remote controller.)
- Prohibition 3 The remote controller cannot be used for operation mode change and temperature setting. (All other operations are possible from the remote controller.)
- Prohibition 4 The remote controller cannot be used for operation mode change. (All other operations are possible from the remote controller.)

Remote Control

The LAN terminal on this unit enables you to connect it to a network. Connecting to internet will enable you to operate the unit and check the status using a PC from remote location.



Display image on the remote PC is same design as the controller unit.

# System configuration

The following is an example of a system configuration.

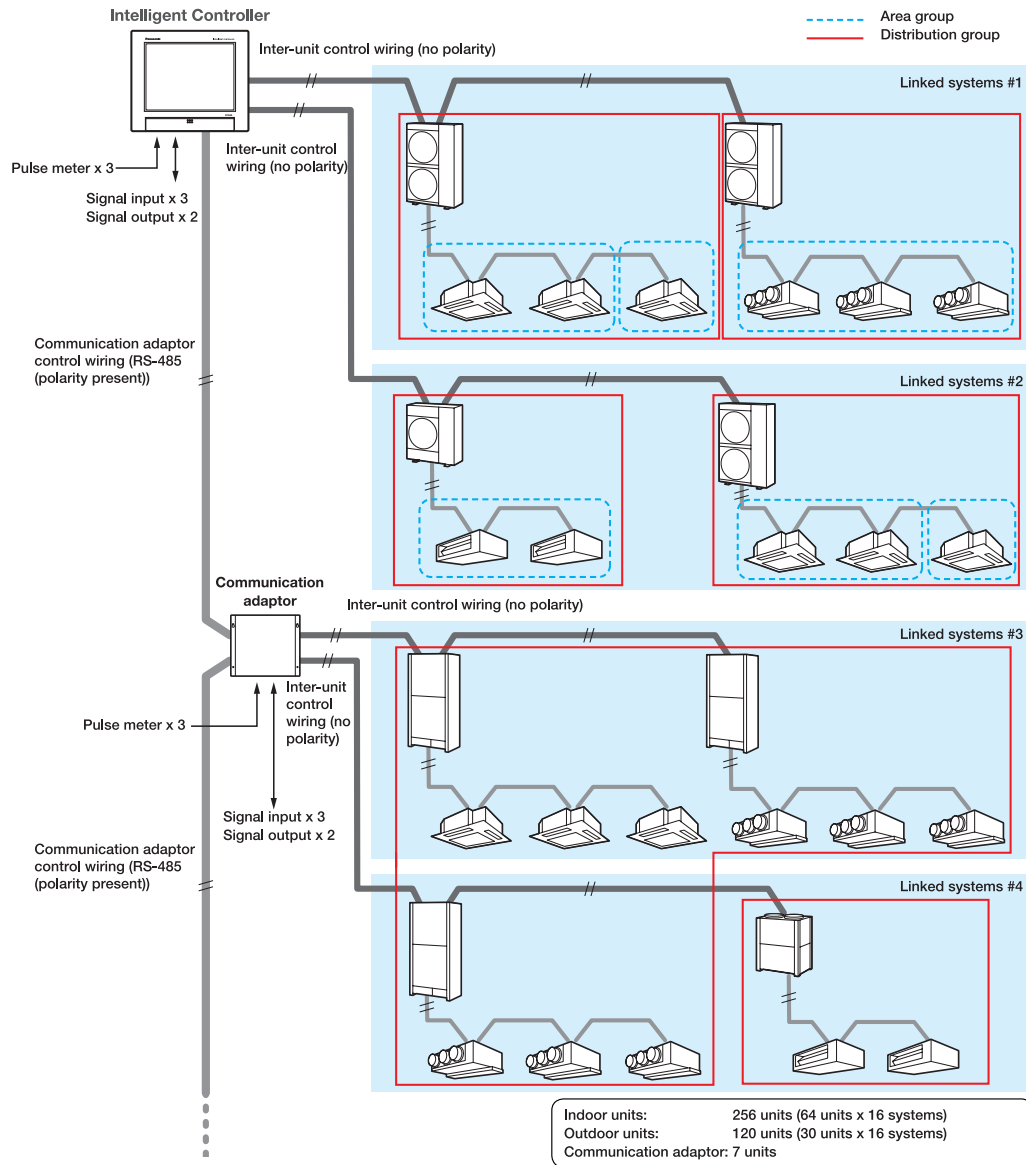

## Communication adaptor (CZ-CFUNC2)



\* Required when more than 129 indoor units are connected.



# Panasonic total air conditioning management system P-AIMS

## P-AIMS Basic software / CZ-CSWKC2

Up to 1024 indoor units can be controlled by one PC

Functions of basic software

- Standard remote control for all indoor units
- Many timer schedule programs can be set on the calendar
- Detailed information display for alarms
- CSV file output with alarm history, operating status.
- Automatic data backup to HDD

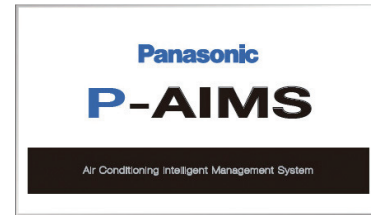

With 4 upgrade packages the basic software can be upgraded to suit individual requirements

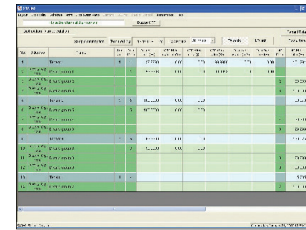
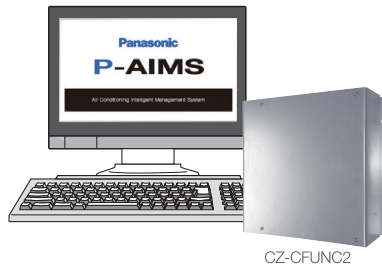

The P-AIMS is ideal for large areas/buildings such as shopping centers, universities and office buildings. Each line can have max.8C/A units, and control max.512 units. In total, 1024 indoor units can be controlled by 1 "P-AIMS" PC.

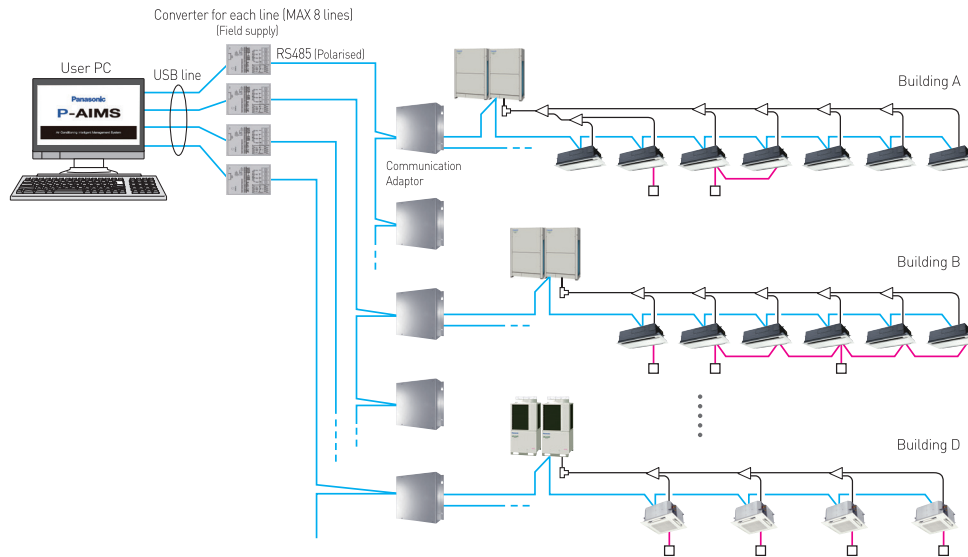

Recommended computer specs (Desktop type)

Operating system	Windows 10 Pro 64bit Windows 8.1 Professional 64bit
CPU	Intel Core™ i5-6500 3.20GHz or higher (Recommended computer) Intel Core™ i7-7700 3.60GHz or higher (When installing Layout Display Software or using 512 or more indoor units)
Memory	8GB or larger
HDD	SSD (Solid State Drive) 250GB or larger
Monitor	1920 × 1080 (full HD) Recommended (1280 × 1024 (SXGA) minimum)
External HDD	1920 × 1080 (full HD) Required (when installing Layout Display Software)
External HDD	500GB or larger (An external power supply type is preferable because the HDD will be used for backing up data.)
LAN	Network adaptor equipped machine (when Web Software or BACnet Communication Software installed)
UPS (Field Supply)	Select a UPS with a sine output wave form

**P-AIMS optional software  
CZ-CSWAC2 for Load distribution**

**Load distribution calculation for each tenant**

- Air-conditioner load distribution ratio is calculated for each unit (tenant) with used energy consumption data (m3, kWh).
- Calculated data is stored with CSV type file.
- Data of last 365 days is stored

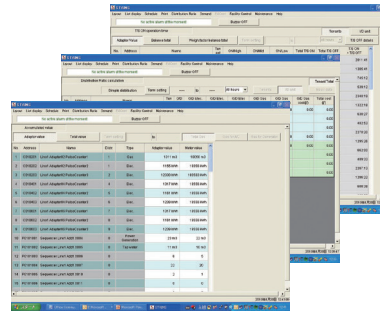

**P-AIMS optional software  
CZ-CSWWC2 for Web application**

**Web access & control from remote station**

- Accessing P-AIMS software from remote PC.
- You can monitor/operate FSV systems by using Web browser (Internet Explorer).



**P-AIMS optional software  
CZ-CSWGC2 for Object layout display**

**Whole system can be controlled visually**

- Operating status monitor is available on the layout display.
- Object's layout and indoor unit's location can be checked at once.
- Each unit can be controlled by virtual remote controller on the display.
- Max 4 layout screens are shown at once.

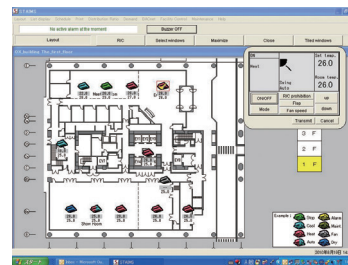

**P-AIMS optional software  
CZ-CSWBC2 for BACnet software interface**

**Connectable to BMS system**

- Can communicate with other equipment by BACnet protocol.
- FSV systems can be controlled by both BMS and P-AIMS.
- Max 255 indoor units can be connected to 1 PC (that has P-AIMS basic & BACnet software).

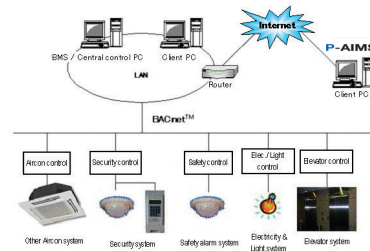



# T10 Terminal for External Control (Digital Connection)

Connecting an FSV indoor unit to an external device is easy. The T10 Terminal featured in the electronic circuit board of all indoor units enables digital connection to external devices.



## 1. T10 Terminal Specification (T10:CN061 at indoor unit PCB)

- **Control items:**
  1. Start/stop input (eg hotel key card, push button operation)
  2. Remote controller prohibit input
  3. Operation status output (eg fresh air fan)
  4. Fault status output

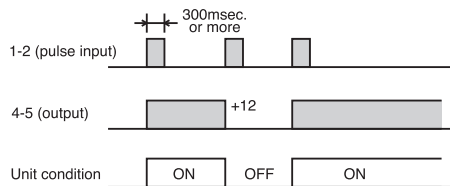

NOTE: The wire length from indoor unit to the Relay must be within 2.0m. Pulse signal changeable to static with JP cutting. (Refer to JP001)

- **Example of wiring**

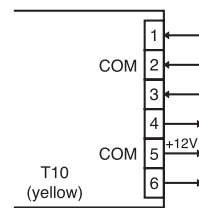

### Condition

1. 1-2 (Pulse input): Unit ON/OFF condition switching with a pulse signal. (1 pulse signal: shortage status more than 300msec. or more)
2. 2-3 (Static input): Open/ Operation with Remote is permitted. (Normal condition) Close/ Remote controller is prohibited.
3. 4-5 (Static output): 12V output during the unit ON. / No output at OFF.
4. 5-6 (Static output): 12V output when some errors occur / No output at normal.

## 2. Usage Example

### Forced OFF control

- **Condition**  
1-2 (Static input): Close/ Operation with Remote is permitted. (Normal condition) Open/ Unit is forcibly OFF and Remote controller operation is prohibited.
- **Example of wiring**

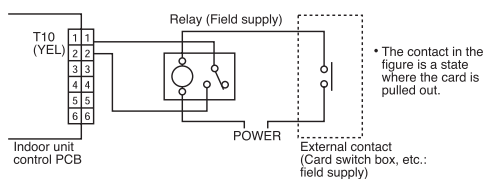

NOTE: The wire length from indoor unit to the Relay must be within 2.0m

### Operation ON/OFF signal output

- **Condition**  
4-5 (Static output): 12V output during the unit ON / No output at OFF
- **Example of wiring**

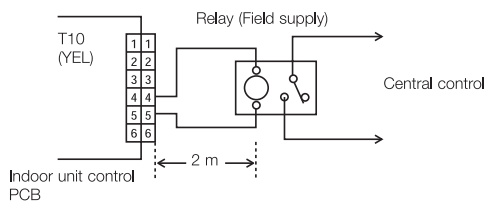

NOTE: The wire length from indoor unit to the Relay must be within 2.0m. Pulse signal changeable to static with JP cutting. (Refer to JP001)

# Interfaces for External Control (Digital Connection)

## Seri-Para I/O unit for each indoor unit (CZ-CAPBC2)



### System example

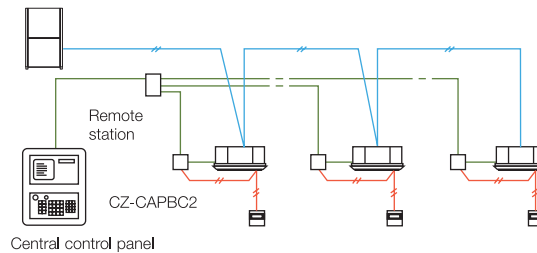

- Control and status monitoring is possible for individual indoor unit (1 group).
- In addition to operation and stop, there is a digital input function for air speed and operation mode.
- Temperature setting and measuring of the indoor suction temperature can be performed from central monitoring.
- The analog input for temperature setting is 0 to 10 V, or 0 to 140 Ohm.
- Power is supplied from the T10 terminal of the indoor units.
- Separate power supply also is possible (in case of suction temperature measuring).

## Interface adaptor (CZ-CAPC3)



### System example

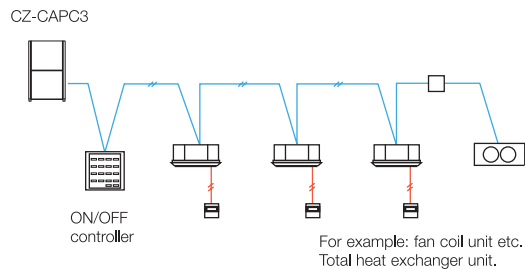

- Control and status monitoring is possible for individual indoor unit (or any external electrical device up to 250 V AC, 10 A) by contact signal.

## Seri-Para I/O unit for outdoor unit (CZ-CAPDC2)



### System example

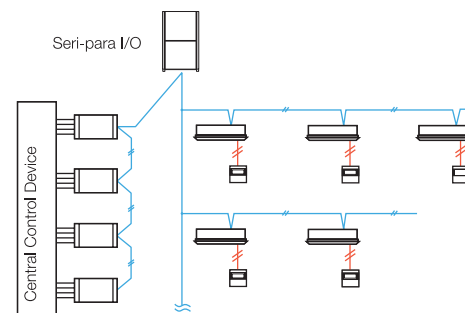

Dimensions	H 80 x W 290 x D 260 mm
Power supply	Single phase 110-120/220-240 V (50/60 Hz), 18 W
Input	Batch operation/Batch stop (non-voltage contact/DC 24 V, pulse signal). Cooling/Heating (non-voltage contact/static signal). Demand 1/2 (non-voltage contact/static signal) (Local stop by switching)
Output	Operation output (non-voltage contact). Alarm output (non-voltage contact)
Wiring length	Indoor/Outdoor operation lines: Total length 1 km. Digital signal: 100 m or shorter

- This unit can control up to 4 outdoor units.
- From the centre control device, mode changing and batch operation/batch stop are possible.
- Required for demand control.

# Serial Interface for 3rd Party External Controller

Example of 3rd party BMS connection with CZ-CFUNC2  
 (For the detail please consult to authorized dealer)

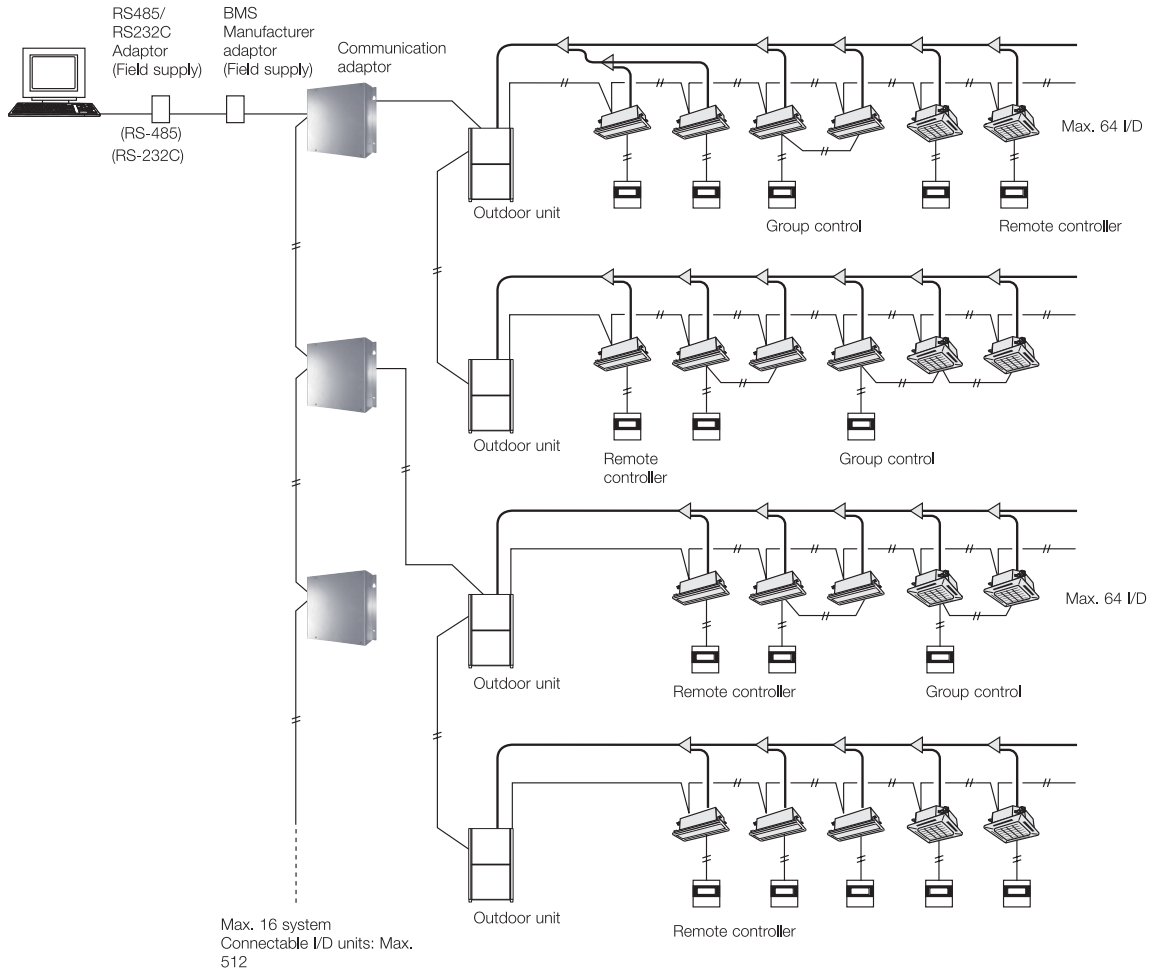

Functions via communication adaptor [CZ-CFUNC2]	
A/C unit settings	Unit ON/OFF
	Mode-change
	Room temperature setting
	Fan speed setting
	Flap setting
	Central control setting
	Filter-sign clear
	Alarm reset
A/C unit status	Unit ON/OFF status
	Operation mode
	Setting temperature
	Fan speed status
	Flap status
	Central control setting
	Filter-sign situation
	Correct/incorrect status
Alarm code	

### Communication Adaptor (CZ-CFUNC2)



Up to 128 indoor units can be connected to one Communication Adaptor.

# Serial Interface for LonWorks Network

## LonWorks Interface (CZ-CLNC2)



- This interface is a communications converter for connecting LonWorks to the control network of FSV.
- From the host connected to LonWorks, basic settings and status monitoring is possible for up to 16 groups of indoor units.

### System example

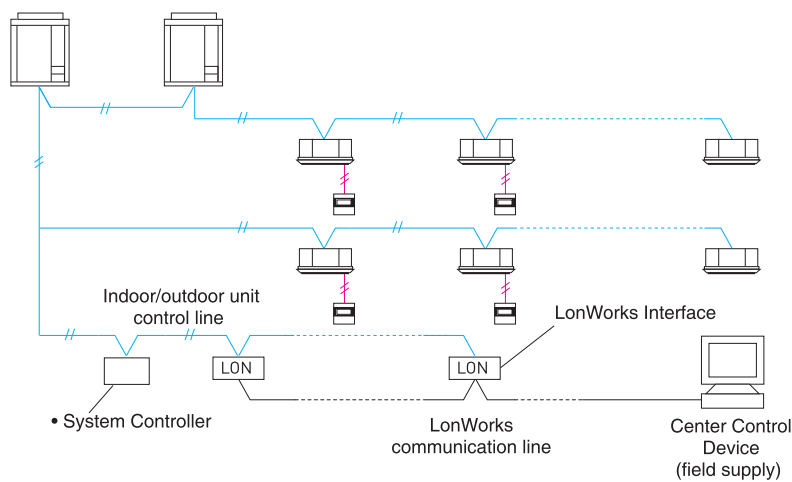

### Functions

A/C unit settings from the LonWorks communicator	Settings for each group of indoor units	Start/stop
		Temp. setting
		Operation mode
		Option 1 settings
		Option 2 settings
A/C unit status notifications made to the LonWorks communicator	Settings for all units	Emergency stop
		Start/stop
		Temp setting
		Operation mode
		Option 1 settings
		Option 2 settings
		Alarm status
		Indoor units with active alarms
Configuration properties		Room temp.
		A/C unit status
		Transmission intervals settings
		Minimum time secured for transmission



# FSV Controller External Dimensions

HIGH-SPEC  
WIRED REMOTE  
CONTROLLER  
(CZ-RTC5)

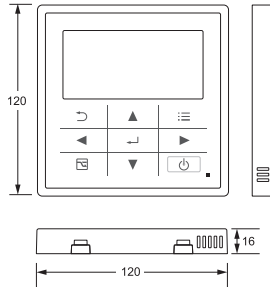

TIMER REMOTE CONTROLLER  
(CZ-RTC4)

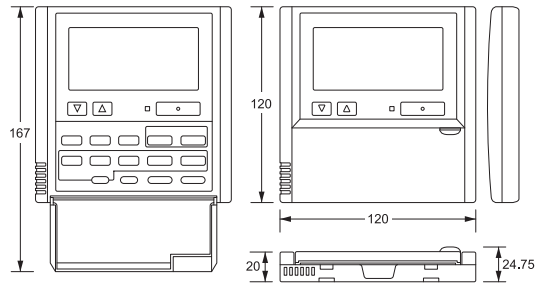

WIRELESS REMOTE  
CONTROLLER  
(CZ-RWS3)

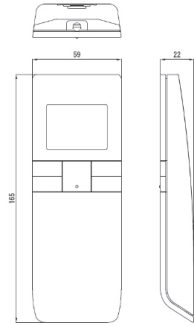

SEPARATE RECEIVER FOR  
WIRELESS REMOTE  
CONTROLLER  
(CZ-RWSC3)

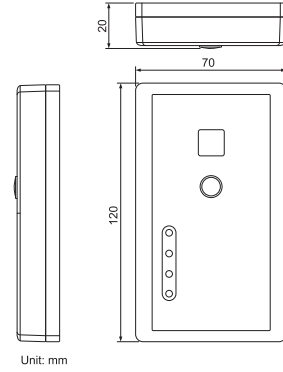

Unit: mm

SIMPLIFIED REMOTE  
CONTROLLER  
(CZ-RE2C2)

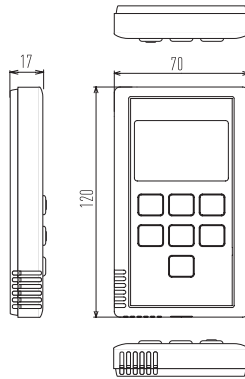

SYSTEM CONTROLLER  
(CZ-64ESMC3)

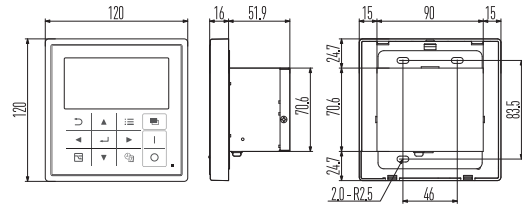

ECONAVI SENSOR  
(CZ-CENSC1)

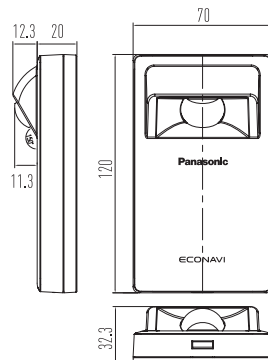

REMOTE SENSOR  
(CZ-CSRC3)

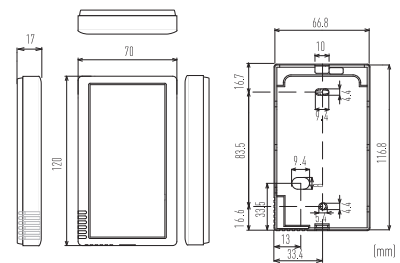

COMMUNICATION ADAPTOR  
(CZ-CFUNC2)

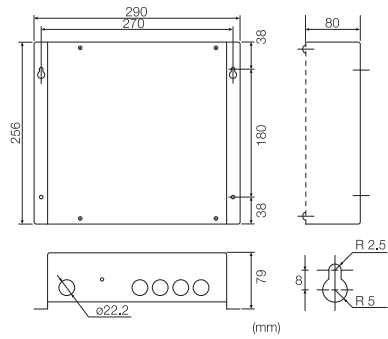

INTELLIGENT CONTROLLER  
(CZ-256ESMC3)

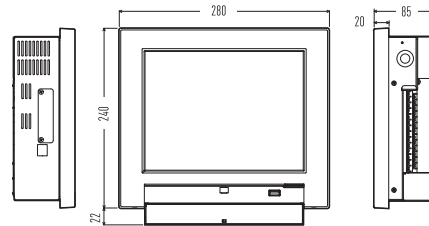

ON/OFF CONTROLLER  
(CZ-ANC3)

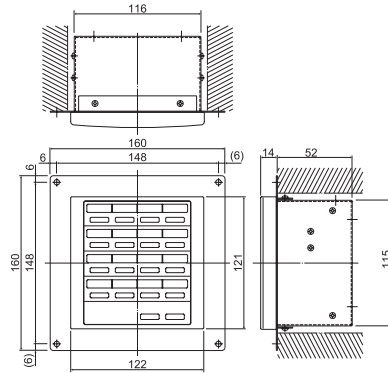

SERI-PARA I/O UNIT FOR EACH INDOOR UNIT  
(CZ-CAPBC2)

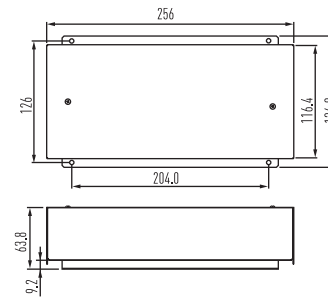

LONWORKS INTERFACE  
(CZ-CLNC2)

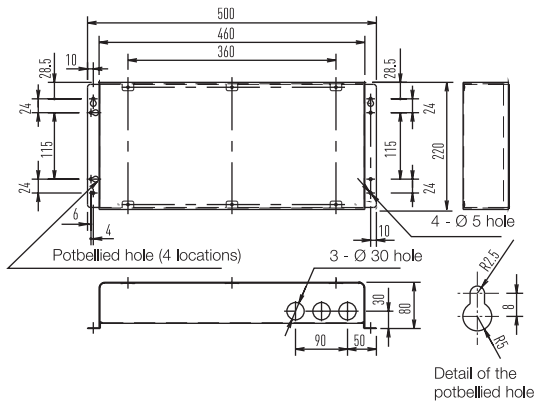

SERI-PARA I/O UNIT FOR OUTDOOR UNIT  
(CZ-CAPDC2)

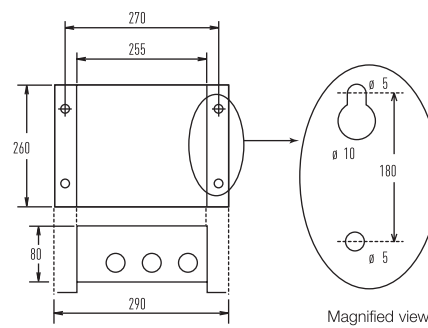

# VRF Renewal

An important drive to further reduce the potential damage to our ozone



R22 is a HCFC and classified as an ozone depleting substance banned under the Montreal Protocol.

Many existing R22 VRF Systems will need to be replaced over the coming years by more modern and efficient R410A VRF Systems.

## Panasonic takes proactive action to switch to R410A refrigerant

Recognising consumers' anxiety and financial difficulties to adapt to the new R22 regulations, Panasonic developed a new cost-effective and simple solution to switch to R410A refrigerant.

### What is Panasonic VRF Renewal?

Panasonic VRF Renewal enables reuse of good quality existing R22 pipe work to be installed with a new high efficiency R410A system.

### What's so unique about Panasonic's solution?

By enabling reuse of existing R22 piping, consumers get to save substantially from reduced installation cost, and without any sacrifices to warranty or performance.

Ozone Depletion Potential		
R22	HCFCs	0.055
R410A	HFC	0
R407C	HFC	0

R22 - The reduction of Chlorine critical for a cleaner future

Before renewing piping, be sure to contact an authorised Panasonic dealer for advice.

## VRF Renewal

Panasonic's Renewal system allows a completely new VRF system, indoor and outdoor units, to be installed using the existing systems pipe work. Panasonic's advanced technology enables the system to work with previously installed pipe work by managing the working pressure within the system down to R22 (3.3 bar) levels. This ensures the system works safely and efficiently without loss of capacity.

The new equipment has potential to increase COP/EER by using state of the art inverter compressor and heat exchanger technology.

Having contacted your Panasonic supplier regarding pipe work restrictions and gained approval to use the Panasonic Renewal System there are three main tests that have to be carried out to ensure that the system can be used effectively.

Firstly a thorough inspection of the pipe work must be carried out and any damage must be repaired.

Secondly an oil test has to be carried out to ensure that the system has not been subject to a compressor burnout during its lifetime.

Lastly a VRF Renewal Kit (CZ-SLK2) has to be installed within the pipe work to ensure that the system is cleaned of any oil residue.



### VRF Renewal Kit (CZ-SLK2) and Sight Glass

The following shows an overview of the VRF Renewal Kit (CZ-SLK2) that is required when existing tubing is reused. If the exact tube length and tube size of the existing tubing are uncertain, attach a sight glass in accordance with the figure below. It will be used for checking the amount of additional refrigerant charge (calculating the amount in Judgment 4 see page 122).

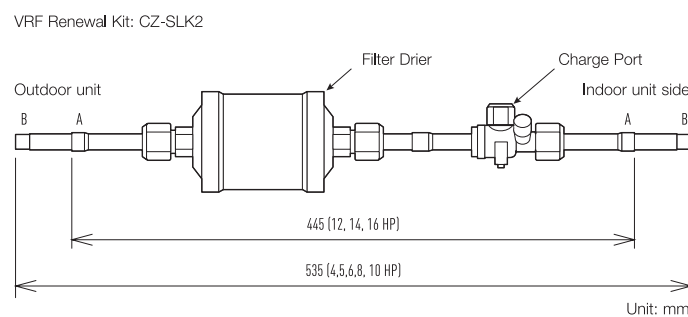

### Attaching the Renewal Kit and sight glass

- To adjust the limited pressure level into 3.3 MPa, special setting is necessary on site.
- A filter drier shall be attached to the liquid tubing of each outdoor unit.
- Do not need to remove Renewal Kit after a test run is performed as it can be retained for normal operation.
- When attaching Renewal Kit, be extra careful with regards to installation location and orientation of the filter drier and ball valve. Any mistakes will complicate maintenance work.
- Thermal insulation material (field supply: heat resistance of 80°C or higher and thickness of 10 mm or greater) shall be applied to the Renewal Kit.
- The filter drier of the Renewal Kit may need to be replaced depending on the condition of the existing unit. Use a Danfoss DMB 164 as the replacement filter drier (field supply).

#### Connecting tube dimensions (Inch mm)

A Ø 1/2 (12.7) (12, 14, 16 HP)

B Ø 3/8 (9.52) (8, 10 HP)

Note: If the tube size does not match that of the existing tubing, use a reducer (field supply) to adjust the tube diameter.

#### Sight glass (field supply)

If the exact tube length and tube size of the existing tubing are uncertain, attach a sight glass to the liquid tubing, and use it to check whether there is an appropriate amount of additional refrigerant charge.

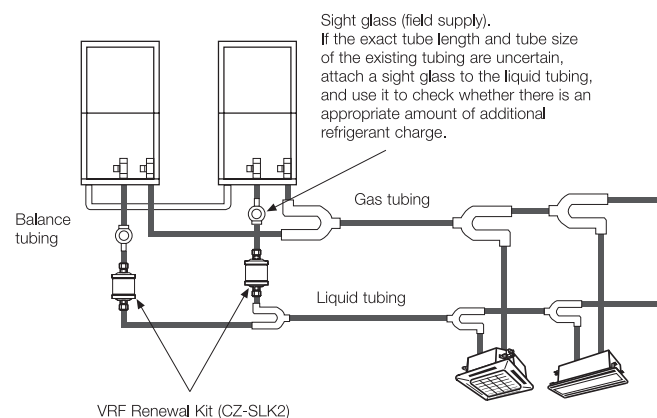



# Procedure for VRF Renewal

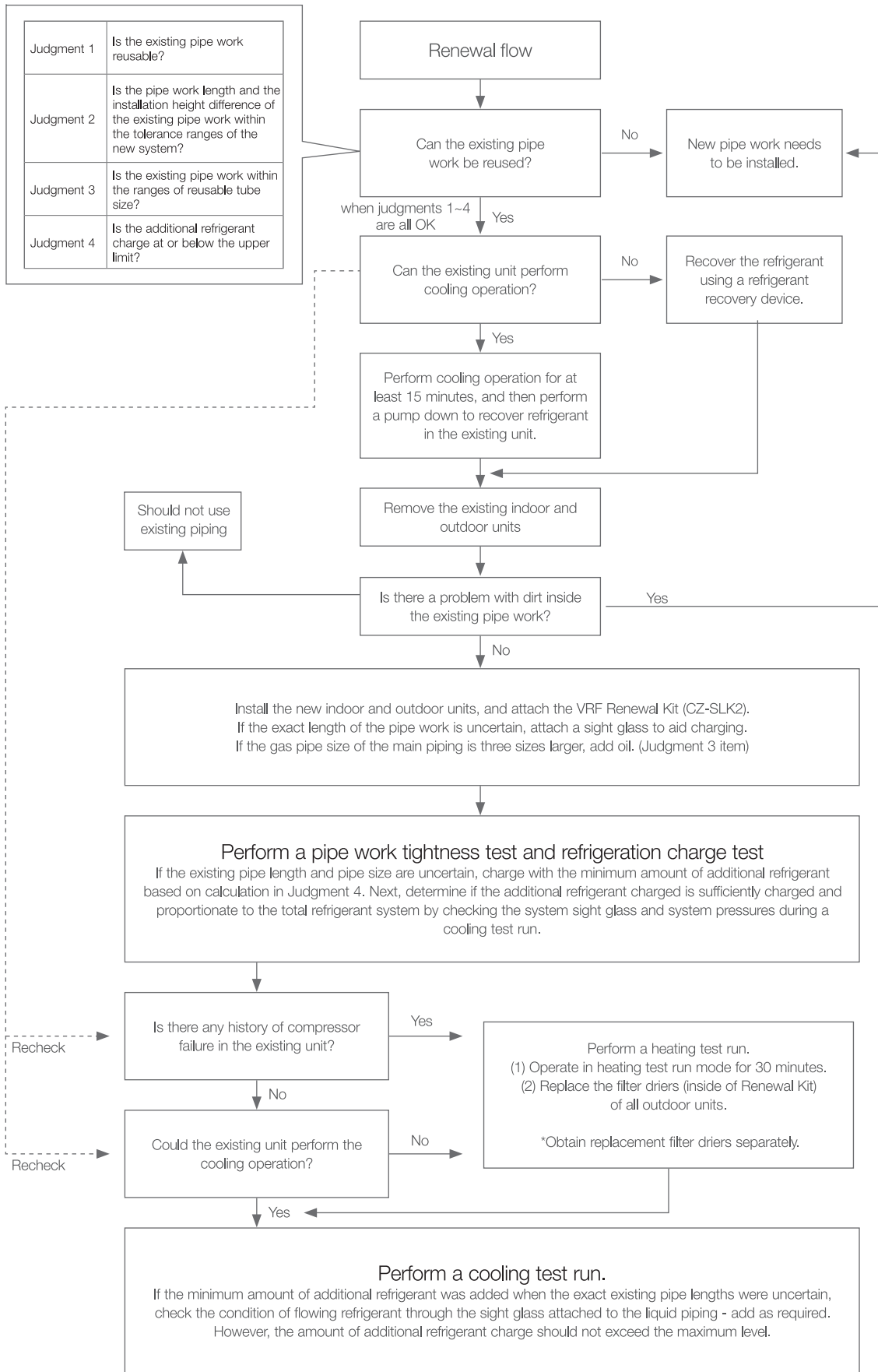

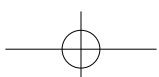
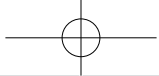



# A Globally Trusted Air Conditioning Brand

With roots going back 60 years, the Panasonic Air Conditioning Business Division has grown to become a multinational company recognised around the world. Driven by a never-ending quest for product innovation, the group has evolved from manufacturing compressors to providing comprehensive air conditioning solutions. Panasonic has become a brand that people trust to deliver products with superior quality and reliability.

## Panasonic's persistent innovation spurs the evolution of air conditioning solutions.

Starts production of absorption chillers

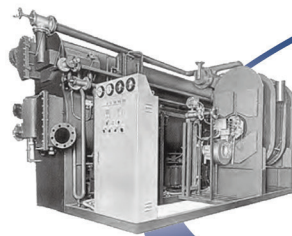

1971

Introduces first GHP (gas heat pump) VRF air conditioner



1985

### 1957

- Start of the Home Cooler business

### 1958

- Panasonic (using the National brand) introduces its first Home Cooler, a window-type air conditioner model



- Electrical Appliance Business Group (Kadoma) starts manufacture of Home Coolers
- Sales of Home Coolers begin

### 1961

- Starts exports of Home Coolers to South Vietnam

### 1965

- Launches Room Coolers



### 1968

- Begins development of rotary compressors
- The high efficiency and quality of these compressors draw interest from domestic and overseas air conditioner manufacturers
- External sales begin

### 1972

- MAICO, the Division's first overseas manufacturing base, established in Malaysia
- Starts export from MAICO to Japan, Indonesia, Australia, and other markets
- Begins operating twin-based system out of Japan and Malaysia



### 1983

- Launches inverter air conditioners
- Starts sale of Panasonic's first inverter air conditioners
- Inverters grow to become a core technology in the air conditioner industry
- Starts shipment of air conditioners to Panasonic America

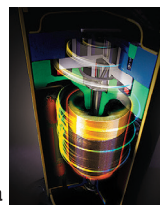

### 1985

- Begins development of scroll compressors
- Scroll compressors bring high efficiency, low noise, and low vibration in comparison to rotary compressors

### 1990

- Launches world's first air conditioner equipped with compact scroll compressor

### 1993

- Establishes Matsushita-Wanbao (Guangzhou) Air Conditioner (MWAC)
- Establishes Matsushita-Wanbao (Guangzhou) Compressor (MWCC)
- Establishes Matsushita Air Conditioner Engineering (Matsushita ACE)

### 2003

- Launches automatic filter-cleaning function for air conditioners (AC robot)



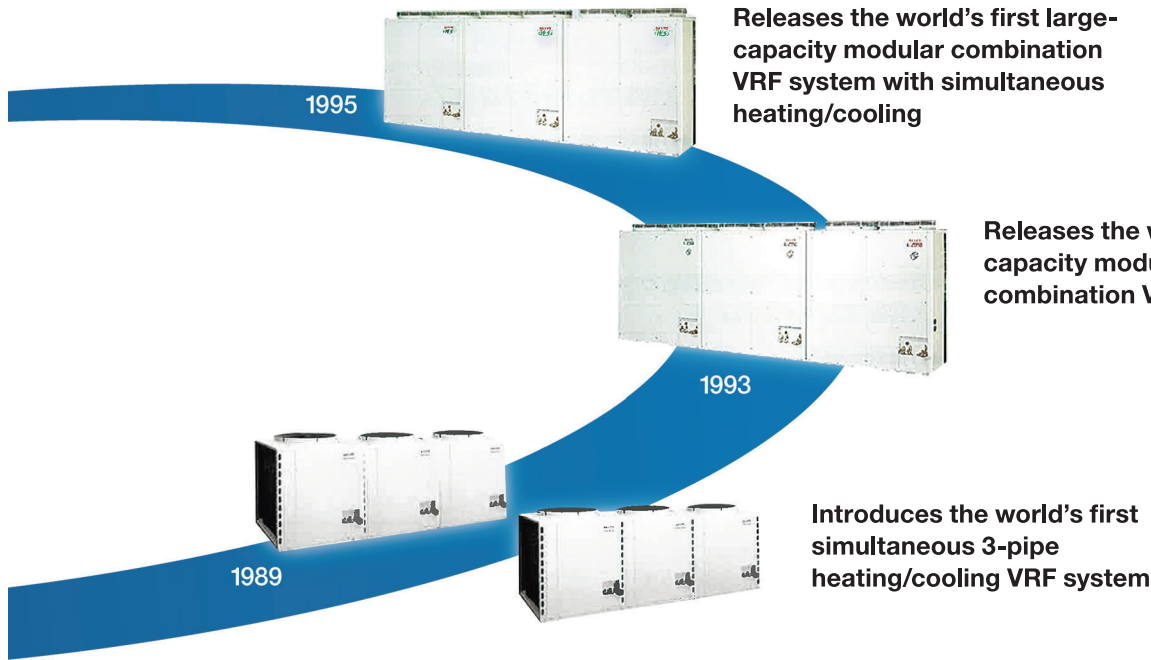
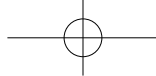

- Debuts quiet, lightweight, compact EcoCute systems with improved energy-saving technology
- EcoCute adopts highly efficient, accumulator-less CO<sub>2</sub> scroll compressor
- CO<sub>2</sub> heat-pump hot water heater (EcoCute) uses non-toxic, non-combustible natural refrigerant (CO<sub>2</sub>) instead of Freon, to reduce environmental impact
- Begins production of new energy-saving mini-VRF series multi-split packaged air conditioners for residential use



## 2005

- Panasonic products become extremely successful in Japan's air conditioner market
- Innovations such as airstream robots and motion sensors help grow Panasonic's market share

## 2006

- Cumulative global production of Panasonic compressors reaches 200 million units

## 2008

- Starts air-to-water heat pump business in Europe

- Hot water heating considered an eco-friendly alternative to conventional fuel-type heating systems
- At the Energy Conservation Grand Prize awards, Panasonic air conditioners won the Chairman Prize of ECCJ, whilst EcoCute won the Director General Prize of Agency of Natural Resources and Energy (prizes presented by Energy Conservation Center of Japan)
- nanoe technology installed on room air conditioners



## 2009

- Establishes sales company in Europe (PHAAE) dedicated to selling air conditioners
- Panasonic HA Air-Conditioning Europe (PHAAE) strengthens company's commercial air conditioning business

## 2010

- Begins collaboration with SANYO air conditioner business
- Through share exchange, SANYO and Panasonic Electric Works become wholly owned subsidiaries

## 2011

- Launches FSV series of large-capacity VRF air conditioners

## 2012

- New Panasonic Group inaugurated

## 2013

- Expands VRF operation in Malaysia



## 2016

- Partnership started with Schneider Electric
- At the Energy Conservation Grand Prize awards, the room air conditioner "WX series" won the Minister Prize of Economic, Trade and Industry (prize presented by Energy Conservation Center of Japan)







# Reliability and Durability

At Panasonic, we believe that the best air conditioner is one that works quietly and effectively in the background whilst minimising its impact on the environment. People who use our products can look forward to long years of high-quality performance without the need for constant maintenance. As part of our rigorous design and development process, Panasonic air conditioners undergo a variety of stringent tests to ensure their effectiveness and long-term reliability. Tests for durability, waterproofing, shock resistance, and noise are conducted on component parts or on the finished products themselves. As a result of all of these painstaking efforts, Panasonic air conditioners meet even the most demanding industrial standards and regulations in every country where they are sold.



Applying advanced technologies that truly make life better, we live by an unparalleled commitment to product quality. Our approach to product development originates in the DNA of Japanese craftsmanship. Panasonic is building on the Japanese tradition of uncompromising quality control worldwide, developing and manufacturing fine products and delivering them to customers everywhere.

## Durability

At Panasonic we know the importance of a long service life with minimal maintenance. That's why we subject our air conditioners to a wide range of stringent durability tests.



### Long-Term Durability Test

To ensure durability and stable operation for many years, we conduct a long-term continuous operation test under conditions that are much more severe than actual operating conditions.



### Compressor Reliability Test

After the continuous operation test, we remove the compressor from a selected outdoor unit, disassemble it, and examine the internal mechanisms and parts for potential failure. This helps ensure reliable long-term performance under harsh conditions.



### Waterproofing Test

The outdoor unit, which is subject to rain and wind, complies with IPX4 waterproof specifications. Contact sections on printed circuit boards are resin-potted to prevent adverse effects caused by exposure to water (an unlikely occurrence).

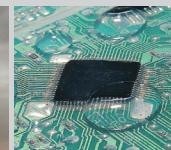

A resin-potted circuit board

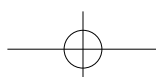



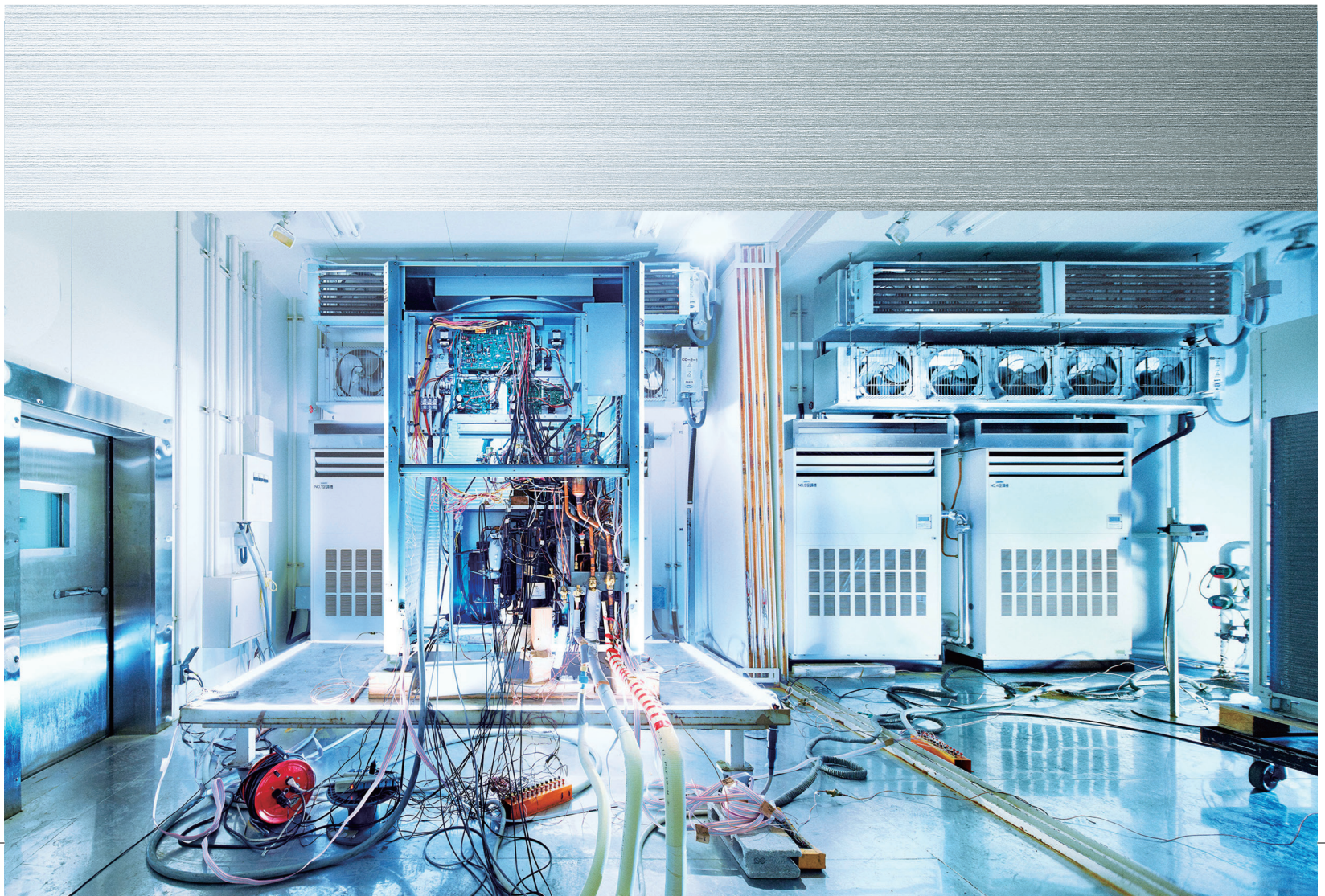
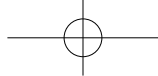

Testing laboratory Panasonic Gunma, Japan (PAPARS)

## International Standard Quality

To uphold the company's reputation around the world, Panasonic strives continuously to offer the highest quality with the lowest possible environment impact.



The strength of the resin material used in a propeller fan is confirmed by a tension test

### Reliable Parts That Meet or Exceed Industrial Standards

In every country where they are sold, Panasonic air conditioners comply with all required industrial standards and regulations. In addition, Panasonic conducts stringent testing to ensure the reliability of parts and materials.



### RoHS / REACH Compliant Parts

All Panasonic parts and materials comply with Europe's strict RoHS/REACH environmental regulations. During the development and production of parts, stringent inspections are conducted on over 100 materials to ensure that no hazardous substances are included.



### Sophisticated Production Process

Panasonic's air conditioner production lines employ state-of-the-art factory automation technologies to ensure products are manufactured efficiently and with uniformly high levels of quality and reliability.

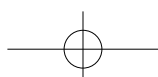



# Global Networking of Heating and Cooling Solutions

In any indoor environment, eco-friendly air conditioning plays a vital role in maintaining our health, comfort, and productivity. Whether it's an office, a hotel, or a shopping mall, every building matters. That's why Panasonic has developed energy-efficient large-scale heating and cooling solutions to suit a variety of business applications. As one of the pillars of Panasonic's BtoB operations, our heating and cooling sector provides comprehensive solutions to businesses around the world. Harnessing our advanced technology and extensive on-site expertise, we serve clients in a diverse range of environments throughout the world.

Panasonic air conditioning solutions are designed from the ground up to meet the specific needs of each location, whilst placing a premium on efficiency and reliability. At every stage, we seek to make optimal use of resources and energy to create solutions that benefit the environment.



## PACT Training Facilities

The 22 Panasonic Air Conditioning Training Centers (PACTs) around the world provide a wide range of support for Panasonic's business-use air conditioning systems. PACT represents Panasonic's unwavering commitment to our sales partners, distributors, and service teams in Europe, Asia, Oceania, and the Americas.



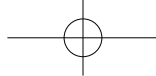

## Quality Assurance from Japan to the World

With a diverse network of production and R&D facilities, Panasonic delivers innovative products incorporating cutting-edge technologies that set the standard for air conditioners worldwide. As our business expands globally, we strive to transcend borders with our superior-quality products.

### Japan



Heating & Cooling Solutions Business Division, Air-Conditioning Business Unit (Appliances Company) (Shiga, Japan)

- Established April 1972
- Appliances Company HQ
- Home Appliances Business Group
- Corporate Engineering Division



Commercial Air-Conditioning Business Unit (Gunma, Japan)

- Established July 1959
- Air conditioners
- Cold-chain/refrigeration products

### Malaysia



PAPAMY Panasonic Appliances Air Conditioning Malaysia Sdn Bhd.

- Established April 1972
- Air conditioners
- Air-to-water heat pumps



PAPARADMY Panasonic Appliances Air Conditioning R&D Malaysia Sdn. Bhd.

- Established June 1991
- R&D for air conditioners
- Air-to-water heat pumps



PAPAMY Compressor

- Established January 1987
- Rotary compressors for air conditioners



PAPAMY Compressor R&D

- Established September 1997
- R&D for rotary compressors

### China



PAPAGZ Panasonic Appliances Air Conditioning (Guangzhou) Co., Ltd.

- Established June 1993
- Air conditioners



PRDCS Panasonic R&D Center Suzhou Co., Ltd.

- Established April 2002
- Air conditioners
- R&D for home appliance products



PAPARDL Panasonic Appliances Air-Conditioning and Refrigeration (Dalian) Co., Ltd.

- Established September 1992
- Air conditioners

### Taiwan



PTW Panasonic Taiwan Co., Ltd.

- Established October 1962
- Air conditioners
- Automotive air conditioners
- Home appliance products



PMI Panasonic Manufacturing Indonesia

- Established September 1965
- Air conditioners
- Home appliance products



PMPC Panasonic Manufacturing Philippines Corporation

- Established September 1967
- Air conditioners
- Home appliance products



PI Panasonic India Pvt. Ltd.

- Established December 2012
- Room Air conditioners

### Indonesia

### Philippines

### India

## PACT Headquarters and Bases

### EUROPE

#### Germany Wiesbaden



#### Nordic Stockholm



#### Hungary Budapest



#### Russia (CIS) Moscow



#### Spain Barcelona

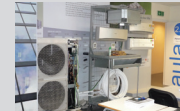

#### Spain Madrid



#### France Paris



#### Italy Milan

#### Czech Rep. Prague

#### France Lyon

#### UK Bracknell

### ASIA

#### Malaysia Shah Alam



#### Vietnam Hanoi



#### India New Delhi



#### Thailand Bangkok

#### Taiwan Zhonghe

#### Indonesia Jakarta

#### China

### OCEANIA

#### Australia Sydney

#### New Zealand Auckland

### AMERICAS

#### Latin America Panama

#### USA Atlanta





# Panasonic VRF Global Project References

Panasonic air conditioning systems provides comprehensive solutions to businesses around the world. Harnessing our advanced technology and extensive on-site expertise, we serve clients in a diverse range of environments throughout the world.

## HOTEL

**Australia** Travelodge Hobart



Air Conditioning System:  
VRF 3-way FSV MF2 series 8 systems  
Indoor Units: 116 units  
Cooling Capacity:  
302 kW / 86 USRT



**Indonesia** Patra Jasa Hotel



Air Conditioning System:  
VRF 2-way FSV ME1 series 14 systems  
Indoor Units: 132 units  
Cooling Capacity:  
677 kW / 193 USRT



**Spain** Hotel Claris 5 GL



Air Conditioning System:  
VRF 2-way ME1&LE1 series 11 systems  
VRF 3-way MF1 series 14 systems  
Indoor Units: 233 units  
Cooling Capacity: 769 kW / 218 USRT



**Spain** Monument Hotel



Air Conditioning System:  
VRF 2-way ME1 series 4 systems,  
VRF 3-way 12 systems  
Indoor Units: 171 units  
Cooling Capacity:  
592 kW / 168.33 USRT



**Russia** River Park Hotel



Air Conditioning System:  
VRF 2-way ME1 series 47 systems  
Indoor Units: 96 units  
Cooling Capacity: 788 kW / 224 USRT

**Germany** The LEGOLAND Castle Hotel



Air Conditioning System:  
VRF 3-way MF2 12 systems  
Indoor Units: 144 units  
Cooling Capacity:  
592 kW / 168.33 USRT



**Cambodia** Mayor Hotel



Air Conditioning System:  
FSV VRF and Package Aircon (PAC) 10 systems  
Indoor Units: 320 units

**Cambodia** Baitong Hotel



Air Conditioning System:  
FSV VRF 20 systems  
Indoor Units: 165 units

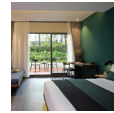

## OFFICE

**Malaysia** Gapurna project



Air Conditioning System:  
VRF 2-way FSV ME1 series 109 systems  
Indoor Units: 537 units  
Cooling Capacity:  
5,370 kW / 1,526 USRT



**Malaysia** Plaza 33 Office Block A

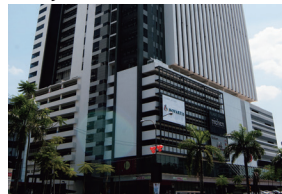

Air Conditioning System:  
VRF 2-way FSV ME1 series 99 systems  
Indoor Units: 153 units  
Cooling Capacity:  
3,667 kW / 1,042 USRT



**Thailand** Areeya



Air Conditioning System:  
VRF 2-way FSV ME1 series 19 systems  
Single split system 67 systems  
Indoor Units: 85 units  
Cooling Capacity:  
1,519 kW / 432 USRT



**HongKong** King Yip Road



Air Conditioning System:  
VRF FSM LA1 series 136 systems  
Indoor Units: 294 units  
Cooling Capacity:  
2,108 kW / 599 USRT



**England** Soapworks

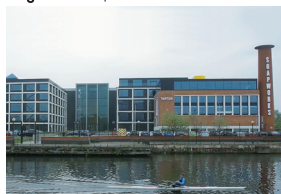

Air Conditioning System:  
VRF 3-way MF2 77 systems  
with ERV 167 systems



**Spain** PTA Malaga



Air Conditioning System:  
VRF 2-way ME1 series 20 systems  
Indoor Units: 74 units  
Cooling Capacity:  
908 kW / 258 USRT



**Russia** Russian Government Building



Air Conditioning System:  
VRF 2-way ME1 series 42 systems  
Indoor Units: 277 units  
Cooling Capacity:  
2,045 kW / 581 USRT



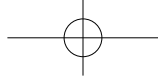

## RETAIL

**Italy** Le Centurie CENTRO COMMERCIALE



Air Conditioning System:  
VRF 3-way MF1 series  
18 systems  
Indoor Units: 57units  
Cooling Capacity:  
656 kW / 186 USRT



**India** Sai Aarav Motors, Mehsana



Air Conditioning System:  
VRF 2-way FSV ME1 series 3 systems  
Indoor Units: 19 units  
Cooling Capacity: 156 kW / 44 USRT

**Russia** Sun City Mall



Air Conditioning System:  
VRF 2-way ME1 series  
47 systems,  
VRF 3-way 12 systems  
Indoor Units: 283 units  
Cooling Capacity:  
1,605 kW / 456 USRT



## SCHOOL

**United States** Shippensburg University



Air Conditioning System:  
VRF 3-Way MF1 series  
55 systems  
Indoor Units: 530 units  
Cooling Capacity:  
1,498 kW / 426 USRT



## SCHOOL

**Malaysia** Xiamen University



Air Conditioning System:  
VRF FSV Systems 110 systems  
Indoor Units: 1,349 units  
Cloud adapter: CZ-CFUCC1 17pcs

**Russia** Technopark of Nobosibirsk Academgorodok



Air Conditioning System:  
VRF 2-way ME1 series 38 systems,  
VRF 3-way 12 systems  
Indoor Units: 234 units  
Cooling Capacity:  
1,487 kW / 422 USRT



## HOSPITAL

**Indonesia** Bekasi Hospital



Air Conditioning System:  
VRF 2-way FSV ME1 series  
42 systems  
Indoor Units: 283 units  
Cooling Capacity:  
1,834 kW / 524 USRT



**Indonesia** Persada Hospital



Air Conditioning System:  
VRF 2-way FSV ME1 series  
21 systems  
Indoor Units: 116 units  
Cooling Capacity:  
989 kW / 281 USRT



## RESIDENTIAL

**China** Star River Group Luxury Condominium



Air Conditioning System:  
VRF Master series 966 systems  
Indoor Units: 3,948 systems  
Cooling Capacity:  
16,737 kW / 4,755 USRT



**Singapore** Punggol Eco-Town



Air Conditioning System:  
Inverter multi-split  
room air conditioner  
Indoor Units:  
Wall mounted S series (with ECOAVI)  
Control System: Panasonic HEMS



**Hong Kong** Gloucester Road Project

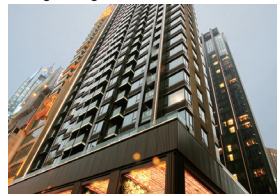

Air Conditioning System:  
VRF FSM LA1 series 67 systems  
Twenty series 105 systems  
Indoor Units: 255 units  
Cooling Capacity: 1,391 kW / 395 USRT

**Hong Kong** The Green Project



Air Conditioning System:  
VRF FSM LA1 series 239 systems  
Twenty series 538 systems  
Indoor Units: 999 units  
Cooling Capacity:  
6,425 kW / 1,825 USRT



**India** Royal Orchids Eco-Green Homz



Air Conditioning System:  
VRF 2-way FSV ME1 series  
22 systems,  
Indoor Units: 139 units  
Cooling Capacity:  
802 kW / 228 USRT



**India** Heera Windfaire



Air Conditioning System:  
VRF 2-way FSV ME1 series 96 systems,  
VRF 3-way 12 systems  
Indoor Units: 479 units  
Cooling Capacity: 2,184kW / 620 USRT

**Panama** Mosaic Building PANAMA PACIFICO



Air Conditioning System:  
VRF 2-way FSV LE1 series 156 systems  
Indoor Units: 357 units  
Cooling Capacity: 2,338 kW / 664 USRT

**Cambodia** HCN Mall and Resident



Air Conditioning System:  
FSV VRF series 4 systems  
Indoor Units: 100 units



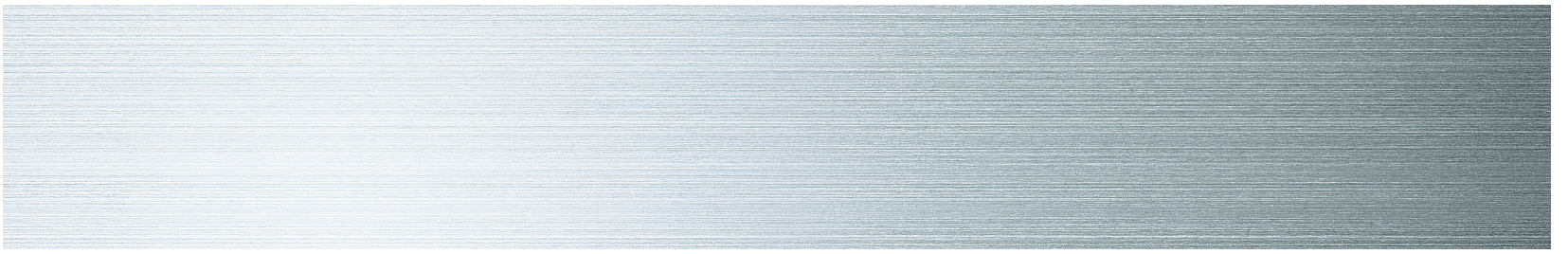
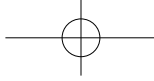

# MALL

## Cambodia TK Royal



Air Conditioning System:  
FSV VRF  
15 systems  
Indoor Units: 740 units



## Cambodia The Penthouse Residence



Air Conditioning System:  
FSV VRF series  
83 systems  
Indoor Units: 1357 units

## Cambodia The Gateway



Air Conditioning System:  
FSV VRF series  
20 systems  
Indoor Units: 314 units



## Cambodia Chip Mong Noro Mall



Air Conditioning System:  
FSV VRF series  
10 systems  
Indoor Units: 125 units

